

تسعى الشركة العربية للتنظيف دائما لجلب ما هو مفيد وجديد في عالم التنظيف

لقد كانت الشركة العربية للتنظيف في الطليعة دائما ، وذلك من خلال تقديم أروع حلول التنظيف بخبرة امتدت لأكثر من **٤٠ سنة** من الزمان ، وتوفيرها لأفضل مستلزمات التنظيف العالمية ، كما تقوم بخدمة كافة القطاعات بأعلى معايير الجودة والتجهيز والدعم الفني.

ونحن نفخر بتقديم كل ما هو جديد ومتطور من الناحية التكنولوجية والمنتجات صديقة البيئة والمعتمدة رسميا من خلال هذا الكتالوج وإدخال خط جديد من المنتجات عالية الجودة تحت علامتنا التجارية.

وتتميز الشركة العربية للتنظيف بأنفردتها دائما بأفضل مستلزمات التنظيف كما نسعى جاهدين للمحافظة على الثقة الممنوحة لنا من قبل عملائنا.

Cleanplus هي علامة تجارية مسجلة بمكونات ومنتجات من مصادر عالمية.

ACC, always striving to bring exciting new cleaning solutions....

Arab Cleaning Company has always been in the forefront of cleaning solutions, with more than **40 years** of expertise in providing best-in-class in cleaning products from around the world.

Serving all sectors with our Quality standards and state of the art equipments.

We take immense pride in presenting new technologically advance, environmentally friendly and certified products through this catalogue. And introduce new line of quality products under our brand.

ACC is always known for its unique cleaning solution products and we work hard to maintain the trust bestowed upon us by our clients.

Cleanplus is a registered brand with globally sourced components and products.

CLEANPLUS®

Cleaning Chemicals
مواد كيميائية للتنظيف

نظام التخفيف المواد





CLEANING CHEMICALS - كيمائيات التنظيف

Cleaning chemicals with quality certifications from around the world...

مواد التنظيف الكيماوية تتمتع بشهادات الجودة من جميع أنحاء العالم ...

Certified Chemicals



The EU Ecolabel helps you identify products and services that have a reduced environmental impact throughout their life cycle, from the extraction of raw material through to production, use and disposal.

Recognised throughout Europe, EU Ecolabel is a voluntary label promoting environmental excellence which can be trusted



Green Seal™ Certified Chemical product meets the Standard GS-37 based on effective performance, concentrated volume, minimized/ recycled packaging, and protective limits on VOCs and human & environmental toxicity.

Green Seal™ Certified Paper product contains 100% recovered paper fiber and a minimum 45% post-consumer materials, and meets the Green Seal™ environmental standard for bleaching, deinking and packaging. It contains no added inks, dyes, or fragrances.

which respects environment and people Our mission is aimed at combining the development of high performing formulas while respecting both nature and people.

The Zero line was born in 2015 and now, thanks to research and to the significant results achieved, we have widened our range of products by increasing the usage of natural origin raw materials obtained from renewable sources.



What is the definition of eco-friendly? According to Merriam-Webster, the official definition of eco-friendly is: "not environmentally harmful." When it comes to products, that means everything from production to packaging needs to be considered safe for the environment



The major objective of Halal certification for chemicals is the exclusion from the outset of any potential contamination by Haram materials. For example, form oil used as a release agent, or lubricants and emulsifiers, might contain components from Haram animal sources.

Code: STC135

Code: STC105

Code: STC117



منظف متعدد الأغراض سمبل جرين
All Purpose Cleaner Simple Green

- Non-Toxic & Bio-Degradable
- Color & Number coded for easy use proportioning system
- Can be used with or without proportioning system

Packing : 473ml / 3.78/18.9 litres STC105 / 135 / 117

Code: STC134



منظف حمامات سمبل جرين
Bathroom Cleaner Simple Green

- Non-Toxic & Bio-Degradable
- Color & Number coded for easy use proportioning system
- Can be used with or without proportioning system

Packing : 1Gallon / 3.78 litres

Code: STC133



منظف زجاج سمبل جرين
Glass Cleaner Simple Green

- Non-Toxic & Bio-Degradable
- Color & Number coded for easy use proportioning system
- Can be used with or without proportioning system

Packing : 1Gallon / 3.78 litres

Code: STC132



منظف سجاد سمبل جرين
Carpet Cleaner Simple Green

- Non-Toxic & Bio-Degradable
- Color & Number coded for easy use proportioning system
- Can be used with or without proportioning system

Packing : 1Gallon / 3.78 litres

Code: STC101

Code: STC126



مطهر برو 5 سمبل جرين

Disinfectant Pro 5 Simple Green

- One-step disinfectant, virucide, fungicide, mildewstat, cleaner & sanitizer
- Blood-borne pathogen compliant disinfectant kills MRSA, HIV-1, HEP B & C, Avian influenza, 2009 H1N1 flu and more
- No color or fragrance-suitable for food processing facilities

Packing : 3.78Ltr / 18.9 Ltr STC126 / 101

Code: STC102



مطهر برو 3 سمبل جرين

Disinfectant Pro 3 Simple Green

- One-step germicide, virucide, cleaner & deodorizer
- Hospital-grade disinfectant kills MRSA, Salmonella, Pseudomonas, HIV-1 Etc.
- Cleans, disinfects & deodorizes Hospitals prisons, schools, public areas, bathrooms.

Packing : 18.9 litres

Code: STC104



مطهر برو ٣ بلس سيمبل جرين

Disinfectant Pro 3 Plus Simple Green

Simple Green d Pro 3 Plus is a hospital-grade antibacterial cleaner that features an extensive kill list of over 75 different bacteria, viruses and fungi, including antibiotic-resistant superbugs. Provides protection against a wide variety of highly contagious and potentially deadly pathogens. The broad-spectrum, bloodborne pathogen compliant formula is proven effective against HIV, MRSA, staph, E. coli, cold, flu, athlete's foot fungus and more.

Packing : 1Gallon / 3.78 litres

Code: STC106



منظف وملمع استانليس استيل سمبل جرين
Stainless Steel One-Step Cleaner & Polish

- Keeps chrome and stainless steel stain and streak free
- Provides an anti-static surface that resists dust, water spots and finger marks
- Wipes clean with no build up
- Non-toxic* formula

Packing : 32oz / 946ml

Code: STC114



منظف جيل للأيدي سمبل جرين

Hand Cleaner Gel SIMPLE GREEN - 3.78Lt

- Non-Toxic, Biodegradable
- Use with or without water • Contains Pumice and Lanolin
- Non-flammable • No oily residue
- Removes grease, oil, tar, soot, wet paint, carbon, fish and food odors, dirt, grime and more

Packing : 3.78 litres

Code: STC115



مناشف ورقية مبللة آمنة متعددة الاستخدامات ٧٥ طبقة سمبل جرين

Safety Towels Multipurpose Simple Green 75 Wipes

- Non-Toxic, Biodegradable • Non-Flammable, Non-hazardous
- Non-corrosive and Non-abrasive • No color and no added scent • Clean rinsing

Packing : 75Wipes/Tin

Code: STC116



Code: STC129



منظف ومزيل دهون للأواني الزجاجية سمبل جرين

Crystal Industrial Cleaner & Degreaser

- Non-Toxic, Biodegradable • Industrial formulation
- No color and no added scent • Non-flammable
- A4 and A8 USDA ratings

Packing : 3.78Ltr / 18.9 litres STC129/116

Code: STC121



Code: STC128



مزيل الأوساخ والتكلسات سمبل جرين
Lime Scale Remover SIMPLE GREEN

- Dissolves soap scum, hard water stains and mineral deposits
- Non-abrasive and non-flammable
- Non-fuming, organic salt formula
- No bleach, ammonia or phosphorous

Packing : 946ml / 3.78Ltrs STC121/128

Code: STC125



منظف ومزيل دهون صناعي مركز برائحة الليمون سيمبل جرين
INDUSTRIAL Cleaner & Degreaser Con. Lemon Scent

- All-purpose cleaner and degreaser • Removes stains and odors
- Safe for all washable surfaces • Nontoxic, nonabrasive formula
- Noncaustic and solvent-free

Packing : 1Gallon / 3.78 litres

Code: STC130



منظف ومزيل دهون صناعي مركز سمبل جرين
INDUSTRIAL Cleaner & Degreaser Concentrated

- Non-Toxic, Biodegradable
- Non-Flammable, Non-Abrasive • A4, A8 and B2 USDA ratings
- Mild 9.3-9.5 pH • Sassafras or Lemon Scent

Packing : 1Gallon / 3.78 litres

Code: SUI101



معطر جو مركز برائحة الخريف ٧٥٠ مل
Deodorising Essence Autumn -750ml

With its long lasting scent and high concentration, it leaves a lingering fragrance that eliminates any unpleasant smells. A lively and refreshing fragrance, just like autumn itself, which opens with an energetic combination of bergamot, citrus fruits and marine notes, enveloped in an elegant floral bouquet of ylang-ylang and jasmine. The base is a potent blend of fine woods and amber notes.

Packing : 750ml

Code: SUI107



معطر جو مركز برائحة الربيع ٧٥٠ مل
Deodorising Essence Spring - 750ml

With its long lasting scent and high concentration, it leaves a lingering fragrance that eliminates any unpleasant smells. Intense and velvety fragrance with fresh notes of typical springtime flowers, such as hawthorn, lily of the valley and several varieties of lightly fruity rose. A bouquet of harmoniously blended flowers that concludes with persistent lingering base notes of wood and musk

Packing : 750ml

Code: SUI102



منظف حمضي للحمامات ذورائحة عطرية ٧٥٠ مل
Detergent Acid E.L ZERO - Ruby

Descaling detergent based on natural origin organic acid (citric acid). Ideal for bathroom and toilet. Recommended for daily cleaning of taps, bathtubs, showers, tiles etc. The daily usage of Ruby, thanks to anti-redeposition agents, helps prevent scaling. Also suitable for the cleaning of internal surfaces within boats, ships and other transports.

Packing : 750ml

Code: SUI111



رغوة غسيل الإيدي - ايكوليبيل

Soap Foam Hand Wash Lotion

FEATURES Totally ECOLABEL certified system. Cosmetic handwash cream, mild on the skin owing to its moisturizing substances (Aloe Barbadensis). Pleasantly scented

Packing : 5Ltr



فاب-فريش معطر ومنعش للأثاث والأقمشة - Odour Control Fab Fresh		
Code	Packing	Description
ACS101	3.78 Ltrs.	Fab Fresh neutralizes and eliminates malodors and refreshes fabric on furniture, bed spreads, curtains, carpeting, clothing and more. • Concentrated • Non-Staining • Water-Based • Deodorizes Fabrics • Pleasant Fresh Scent • مركز • بدون تلميح • ذو أساس مائي • يزيل الروائح الكريهة من الأقمشة • رائحة منعشة لطيفة



شامبو للشعر والجسم بخلاصة التفاح - Hair & Body Shampoo Apple Essence		
Code	Packing	Description
ACS102	3.78 Ltrs.	A pleasantly scented, all natural pH balanced hair and body shampoo. Apple Essence produces a non-irritating rich lather that rinses away completely, leaving hair and skin feeling soft and clean. This product can be used in lotion soap dispensers. Clear Yellow Heavy Bodied Liquid, Green Apple Odor. شامبو للجسم والشعر معطر وطبيعي متوازن بدرجة الحموضة. ينتج جوهر التفاح رغوة غنية غير مزعجة يتم شطفها بسهولة، مما يجعل الشعر والجلد ناعمين ونظيفين. يمكن استخدام هذا المنتج في أجهزة الصابون. سائل أصفر ذو قوام متميل، برائحة التفاح الأخضر.



مطهر أسطح لطاولات الطعام - Food Surface Sanitizer Nds 10		
Code	Packing	Description
ACS105	3.78 Ltrs.	Use on hard, non-porous surfaces found in restaurants, fast food operations, food establishments, hotels, motels, kitchen, bathroom and other household areas, sports stadiums, health clubs, salons/spas, food processing plants, dairy farms, meat/poultry processing plants Active Ingredients: 10% • pH: 6-8 • Color: Clear • Solubility in Water: Complete • Odor: Mild • يستخدم على الأسطح الصلبة غير المسامية الموجودة في المطاعم ومنافذ الوجبات السريعة والمؤسسات الغذائية والفنادق والمطابخ والحمامات والأماكن المنزلية الأخرى. والملاعب الرياضية والنوادي الصحية والصالونات / المنتجعات الصحية ومصانع الأغذية ومزارع الألبان / مصانع تجهيز اللحوم والدواجن. • المكونات النشطة: 10% • الرقم الهيدروجيني: 6-8 • اللون: شفاف • الذوبان في الماء: كامل • الرائحة: خفيفة



مزيل الدهون - Kitchen Magician Degreaser		
Code	Packing	Description
ACS124	3.785 Litres	Kitchen Magician quickly removes burnt on carbon, grease, oil and fat from almost any kitchen surface including floors, pots, pans, food prep areas, ovens, grills, hoods, vents, deep fat fryers, griddles, etc. Alkaline-Based • Highly Concentrated • Penetrating • Quick Acting • Multiple Uses • متوفر بنكهة جوز يزيل Kitchen Magician بسرعة حرق الكربون والشحوم والزيوت والدهون من أي سطح مطبخ تقريباً بما في ذلك الأرضيات، والأواني، والمقالي، ومناطق تحضير الطعام، والأفران، والشوابع، والشفاطات، والفتحات، والمقالي المميقة، والشوابع، إلخ. القلوية عالية التركيز اختراق التمثيل السريع استخدامات متعددة



مزيل العلكة - Anti Gum Remover Citrus

Code	Packing	Description
ACS103	1 Litre	<p>For the removal of chewing gum, sticky labels, oil & grease and glue residues</p> <ul style="list-style-type: none"> • fast Acting • Penetrates • Leaves no sticky residue <p>لازالة العلكة والعلامات اللاصقة والزيوت والشحوم وبقايا الصمغ</p> <ul style="list-style-type: none"> • التمثيل السريع • مخترق • لا يترك أي بقايا لزجة
	 MADE IN USA	



مزيل دهون انزيمي للمجاري - Drain Opener Bug Bacterial Enzyme

Code	Packing	Description
ACS104	3.785 Litres	<ul style="list-style-type: none"> • Highly Active • Waste Digester • Non Toxic • Non-Acid • Non-Alkaline • Clog Prevention • Grease Trap & Septic Maintenance <p>• نشط للغاية • هضم النفايات • غير سام • غير حامض • غير قلوية</p> <p>• منع الانسداد • مصيدة الشحوم وصيانة الصرف الصحي</p>
	 MADE IN USA	



منظف الفرن والشواية - Oven And Grill Cleaner

Code	Packing	Description
ACS106	3.785 Litres	<p>Break-Off quickly removes burnt on carbon, grease, oils and fats from ovens, grills, hoods, vents, deep fat fryers, griddles, etc.</p> <p>Ready-To-Use • Highly Active • Penetrating • Alkaline-Based • Quick Acting • Easy To Use •</p> <p>تعمل ميزة اقطع على إزالة الكربون والشحوم والزيوت والدهون المحترقة من الأفران والشوايات والشفاطات والفتحات والمقالي العميقة والشوايات وما إلى ذلك.</p> <p>• جاهز للإستخدام • نشط للغاية • اختراق • القلوية • التمثيل السريع • سهل الاستخدام</p>
	 MADE IN USA	



مجفف لماكينة غسيل الصحون - Machine Rinse Aid Additive

Code	Packing	Description
ACS107	18.925 Litres	<p>A highly active blend of low foaming surfactants, wetting agents and water-based solvents formulated to prevent spotting and streaking on pots, pans, dishes, glasses, utensils, etc.</p> <p>Highly Active • Low Foaming • Water - Based • Prevents Spotting & Streaking •</p> <p>مزيج نشط للغاية من مواد خافضة للتوتر السطحي منخفضة الرغوة ، وعوامل ترطيب ومذيبات ذات أساس مائي مصنعة لمنع البقع والتقطيع على الأواني ، والمقالي ، والأطباق ، والأكواب ، والأواني ، إلخ.</p> <p>• نشط للغاية • رغوة منخفضة • ذو أساس مائي • يمنع الإكتشاف والتقطيع</p>
	 MADE IN USA	



منظف لماكينة غسيل الصحون - Machine Dishwash Detergent Brute

Code	Packing	Description
ACS108	18.925 Litres	<p>Brute Machine Dish Detergent quickly emulsifies and removes animal fat, grease, oil, food and protein based soils from pots, pans, dishes, glasses, utensils, etc.</p> <p>Highly Active • Powerful • Quickly Emulsifies • Grease Cutter •</p> <p>منظف الأطباق الغاشمة يستحلب بسرعة ويزيل الدهون الحيوانية والشحوم والزيوت والأغذية والبروتينات من الأواني والمقالي والأطباق والأكواب والأواني ، إلخ.</p> <p>• نشط للغاية • قوي • يستحلب بسرعة • قاطع الشحوم</p>
	 MADE IN USA	



منظف الحجر والرخام - Stone Cleaner Marble Clean

Code	Packing	Description
ACS109	3.785 Litres	A highly active blend of low foaming surfactants, wetting agents and water-based solvents formulated to prevent spotting and streaking on pots, pans, dishes, glasses, utensils, etc Restores • Cleans • Brightens • Pleasantly Scented • مزيج نشط للغاية من مواد خافضة للتوتر السطحي منخفضة الرغوة ، وعوامل ترطيب ومذيبات ذات أساس مائي مصنعة لمنع البقع والتقطيع على الأواني ، والمقالي ، والأطباق ، والأكواب ، والأواني ، إلخ . • نشط للغاية • رغوة منخفضة • ذو أساس مائي • يمنع الإكتشاف والتقطيع
	 MADE IN USA	



مزيل للمعة - Speed Stripper Mop & Strip

Code	Packing	Description
ACS110	3.785 Litres	Mop & Strip rapidly penetrates and dissolves multiple layers of finish with or without a floor machine. Blue Liquid, Butyl Odor. Economical • Fast Acting • Emulsifies Old Finish for Easy Removal • تخترق المسحة والقطاع بسرعة طبقات متعددة من التشطيب مع أو بدون آلة الأرضيات. سائل أزرق ، رائحة بوتيل . • اقتصادية • التمثيل السريع • يستحلب النهاية القديمة لسهولة الإزالة
	 MADE IN USA	



ملمع الأرضيات - Floor Polish Elegant

Code	Packing	Description
ACS111	3.785 Litres	Elegant works well with any low or high speed maintenance program. Opaque, Off-White Liquid, Ammonia Odor. Ultra Wet-Look Gloss • High Solids • Extended Durability • أنيق يعمل بشكل جيد مع أي برنامج صيانة منخفض أو عالي السرعة. معتم . سائل أبيض ، رائحة الأمونيا . • ملمع شديد اللعان • مواد صلبة عالية • متانة ممتدة
	 MADE IN USA	



سائل صيانة الأرضية - Floor Maintainer Snap Up Restorer

Code	Packing	Description
ACS112	3.785 Litres	Snap-Up extends the life of floor polish by filling in scratches, removing scuffs and enriching the depth of gloss. This concentrated, water-based acrylic emulsion is formulated for use with high and ultra-high speed burnishing equipment Concentrated • Water-Based • Enriching Gloss • تطالغ بطيل عمر تلميع الأرضيات عن طريق ملء الخدوش وإزالة النتوءات وإثراء عمق اللعان. صُنِع مستحلب الأكريليك المركز ذو الأساس المائي هذا للاستخدام مع معدات الصقل عالية السرعة وفائقة السرعة • مركز • ذو أساس مائي • لعان غني
	 MADE IN USA	



مزيل بقع السجاد - Carpet Spot Remover Spots Off

Code	Packing	Description
ACS113	1 Litre	A ready to use, non-flammable, multi-purpose carpet spotter and pre-spray. Spots Off is effective on both water soluble and oil soluble stains. It will quickly and easily penetrate and lift stains in one application from color-fast carpeting while leaving no sticky residue • Physical state : Liquid • Color : clear • Odor : lemon odor • pH : 8 • Boiling point : 212 - 220 °F مراقب سجاد جاهز للاستخدام وغير قابل للاشتعال ومتعدد الأغراض ومرشح مسبق. تعتبر إزالة البقع فعالة على كل من البقع القابلة للذوبان في الماء والقابلة للذوبان في الزيت. سوف تخترق البقع وتزيلها بسرعة وسهولة في تطبيق واحد من السجاد ذي اللون السريع مع عدم ترك أي بقايا لزجة • الحالة الفيزيائية: سائل • اللون: واضح • الرائحة: رائحة الليمون • الرقم الهيدروجيني: 8 • نقطة الغليان: ٢١٢ - ٢٢٠ درجة فهرنهايت
	 MADE IN USA	



منظف الأرضيات برائحة الليمون - Floor Cleaner Lemon Scrub Soap

Code	Packing	Description
ACS114	3.785 Litres	<p>An all natural vegetable oil based formula for cleaning and deodorizing floor surfaces. Our Scrub Soaps will solubilize dirt, grease and grime, leaving surfaces clean and smelling fresh.</p> <p>All Natural • Lemon / Vegetable Oil based • Cleans • Deodorizes •</p> <p>صابون مقشر الليمون بتركيبه زيت نباتي طبيعي بالكامل لتنظيف وإزالة الروائح الكريهة لأسطح الأرضيات. يعمل صابون التقشير الخاص بنا على إذابة الأوساخ والشحوم والأوساخ، مما يترك الأسطح نظيفة ورائحة منعشة.</p> <p>كل شيء طبيعي • ليمون / زيت نباتي • ينظف • يزيل الروائح الكريهة</p>



منظف الأرضيات برائحة الصنوبر - Floor Cleaner Pine Scrub Soap

Code	Packing	Description
ACS115	3.785 Litres	<p>An all natural vegetable oil based formula for cleaning and deodorizing floor surfaces. Our Scrub Soaps will solubilize dirt, grease and grime, leaving surfaces clean and smelling fresh.</p> <p>Physical state: Liquid • Color: amber • Odor: Pine • pH: 13 • Boiling point: 212 - 220 °F •</p> <p>صابون مقشر الليمون بتركيبه زيت نباتي طبيعي بالكامل لتنظيف وإزالة الروائح الكريهة لأسطح الأرضيات. يعمل صابون التقشير الخاص بنا على إذابة الأوساخ والشحوم والأوساخ، مما يترك الأسطح نظيفة ورائحة منعشة.</p> <p>الحالة الفيزيائية: سائل • اللون: كهرماني • الرائحة: الصنوبر • الرقم الهيدروجيني: 13 • نقطة الغليان: 212 - 220 درجة فهرنهايت</p>



صابون ناعم للأيدي بينك فيلزييت ديلوكس - Hand Soap Pink Velvet Delux

Code	Packing	Description
ACS116	3.785 Litres	<p>This product is designed for use in lotion hand soap dispensers. Opaque Pink Heavy Bodied Liquid, Honey Almond Odor.</p> <p>Lotionized • Non-Irritating • Moisturizes • Rich Creamy Lather • Honey Almond Scent •</p> <p>تم تصميم هذا المنتج للاستخدام في موزعات الصابون اليدوي. سائل كثيف اللون وردي غير شفاف، رائحة عسل اللوز</p> <p>• غسول • غير مزعجة • يرطب • نزي. رغو كريمية • برائحة العسل واللوز</p>



مطهر متعادل للنظيف والتلميع - Neutral Disinfectant Clean & Shine

Code	Packing	Description
ACS117	3.785 Litres	<p>It is an extremely effective disinfectant, deodorizer and cleaner specifically designed for use in Offices, Hospitals, Nursing Homes, Schools and Food Service, etc.</p> <p>Light Yellow Liquid • Pleasant Summer Breeze Fragrance • Concentrated • Cleans, Deodorizes, and Disinfects Hard Surfaces • Dilution: 2 ounces per gallon of water</p> <p>إنه مطهر ومزيل للروائح ومنظف فعال للغاية مصمم خصيصاً للاستخدام في المكاتب والمستشفيات ودور التمريض والمدارس وخدمات الطعام، إلخ</p> <p>• مركز • ينظف ويزيل الروائح الكريهة ويظهر الأسطح الصلبة • التخفيف: 2 أونصة لكل جالون ماء</p>



منظف متعدد للأسطح - Multi Surface Cleaner E-Z Clean

Code	Packing	Description
ACS118	3.785 Litres	<p>A highly concentrated, non-butyl, multi-purpose cleaner/degreaser formulation. E-Z Clean saves time and labor with its rapid and complete emulsification of most common surface soils. Opalescent Yellow-Green Liquid, Lemon Odor.</p> <p>Highly Concentrated • Non-Butyl • Free Rinsing • Phosphate Free •</p> <p>تركيبة منظف / مزيل شحوم عالي التركيز، غير بوتيل، متعدد الأغراض. يوفر إيزي كلين الوقت والجهد من خلال استحلابه السريع والتكامل للتربة السطحية الأكثر شيوعاً. سائل أصفر وأخضر براق ورائحة الليمون</p> <p>• عالية التركيز • غير يتلي • شطف مجاني • خالي من الفوسفات</p>



منظف الزجاج والنوافذ - Glass Cleaner Focus Gc55 Rtu

Code	Packing	Description
ACS119	1 Litre	<p>GC 55 RTU Glass & Window Cleaner is an environmentally responsible, biodegradable, ready to use glass and window cleaner for immediate use.</p> <p>Ready to use • Environmentally responsible Ingredients • Crisp Apple Fragrance •</p> <p>منظف الزجاج والنوافذ GC 55 هو منظف للزجاج والنوافذ مسؤول بيئيًا وقابل للتحلل البيولوجي وجاهز للاستخدام للاستخدام الفوري.</p> <p>• جاهز للاستخدام • مكونات مسؤولة بيئيًا • عطر التفاح المقرمش</p>
		MADE IN USA



مطهر برائحة الليمون - Disinfectant Lemon E

Code	Packing	Description
ACS120	3.785 Litres	<p>Lemon-E is an extremely effective disinfectant, deodorizer, and cleaner suitable for use in health care facilities, schools, food service areas, restrooms and most other public areas.</p> <p>Yellow Liquid • Lemon Odor • Dilution: 4 ounces per gallon of water •</p> <p>Lemon-E مطهر ومزيل للروائح ومنظف فعال للغاية ومناسب للاستخدام في مرافق الرعاية الصحية والمدارس ومناطق الخدمات الغذائية ودورات المياه ومعظم المناطق العامة الأخرى</p> <p>• سائل أصفر • رائحة الليمون • التخفيف: 4 أونصات لكل جالون من الماء</p>
		MADE IN USA



مطهر برائحة الصنوبر - Disinfectant Pine Q

Code	Packing	Description
ACS121	3.785 Litres	<p>Pine Q Detergent/ Disinfectant is an extremely effective disinfectant, deodorizer, and cleaner suitable for use in health care facilities, schools, food service areas, restrooms and most other public areas.</p> <p>Physical state : Liquid • Color : Green • Odor : Pine • pH : 10 • Boiling point : 212 – 220 °F •</p> <p>منظف / مطهر Pine Q هو مطهر ومزيل للروائح ومنظف فعال للغاية ومناسب للاستخدام في مرافق الرعاية الصحية والمدارس ومناطق الخدمات الغذائية ودورات المياه ومعظم المناطق العامة الأخرى .</p> <p>• الحالة الفيزيائية: سائل • اللون الاخضر • الرائحة: الصنوبر • الرقم الهيدروجيني: 10 • نقطة الغليان: 212 – 222 درجة فهرنهايت</p>
		MADE IN USA



منظف المراحيض حمضي - Toilet Bowl Cleaner Mabc 9% Acid

Code	Packing	Description
ACS122	1 Litre	<p>A powerful bowl and urinal cleaner formulated using a safe organic acid technology. MABC removes rust, scale and hard water deposits in toilet bowls and urinals. Clear Pink Liquid, Mint Odor.</p> <p>Physical state: Liquid • Color: Pink • Odor: Lavender • PH : 01 •</p> <p>وعاء قوي ومنظف للبول مُصمم باستخدام تقنية حمض عضوي آمن. يزيل MABC الصدأ ، والترسبات الكلسية والمياه العسرة في مراحيض ومباول. سائل وردي شفاف ، رائحة النعناع.</p> <p>• الحالة الفيزيائية: سائل • اللون الوردي • الرائحة: لافندر • PH : 1</p>
		MADE IN USA



منظف غسيل الصحون - Detergent Dishwash Emerald Green

Code	Packing	Description
ACS123	3.785 Litres	<p>For Use • Dishes • Glassware • Utensils</p> <p>Physical state : Liquid • Appearance : Clear Liquid • Color: Green • Odor : Lemon Odor • pH : 7-8 •</p> <p>للاستخدام • أطباق • الأواني الزجاجية • الأواني</p> <p>• الحالة الفيزيائية: سائل • المظهر: سائل نقي • اللون الاخضر • الرائحة: رائحة الليمون • الرقم الهيدروجيني: 7-8</p>
		MADE IN USA



صابون سائل للأيدي بدون رائحة - Soap Hand Liquid Focus - Fragrance Free

Code	Packing	Description
ACS129	3.785 Litres	<p>Non-Toxic & Bio-Degradable LHS 77 is mildly scented formula is suitable for general purpose use. Dye free, it produces a rich, clean-rinsing lather that leaves skin feeling soft & supple.</p> <p>غير سام وقابل للتحلل LHS 77 هو تركيبة معطرة بشكل معتدل ومناسبة للاستخدام للأغراض العامة. خالٍ من الصبغة ، ينتج رغوة غنية ونظيفة للشطف تجعل البشرة ناعمة ونضرة.</p>
	 MADE IN USA	



صابون سائل للأيدي برائحة التفاح الأخضر - Soap Hand Liquid Focus - Frag: Green Apple

Code	Packing	Description
ACS130	3.785 Litres	<p>Non-Toxic & Bio-Degradable LHS 77 is mildly scented formula is suitable for general purpose use. Dye free, it produces a rich, clean-rinsing lather that leaves skin feeling soft & supple.</p> <p>غير سام وقابل للتحلل LHS 77 هو تركيبة معطرة بشكل معتدل ومناسبة للاستخدام للأغراض العامة. خالٍ من الصبغة ، ينتج رغوة غنية ونظيفة للشطف تجعل البشرة ناعمة ونضرة.</p>
	 MADE IN USA	

The Chemicals for a Cleaner World.



Liquid Soap for Hand, face and body

Code	Packing	Description
SN010	2 x 5Ltrs	<p>For use on HAND, FACE & BODY.</p> <p>Mousse (Rich Thick Creamy) Ecolable 5Ltr/Gal • Spill Free Mouth • Dermatologically tested • Dermatologically tested with hydrating and emollient agents • pH neutral on skin • Item Code. 1091</p> <p>صابون غسيل للأيدي والوجه والجسم ٥ لتر</p> <p>• موس (كريمي سميك وغني) صديق للبيئة ٥ لتر/جالون لا ينسكب على الفم • تم اختياره من قبل أطباء الجلدية مع عوامل مرطبة ومطرية • درجة حموضة محايدة على الجلد • رمز الصنف. ١٩٠١</p>



Liquid Soap AntiBacterial for Hand, face and body

Code	Packing	Description
SN011	2 x 5Ltrs	<p>For use on HAND, FACE & BODY</p> <p>Antibacterial Fragrance Free Securgem • 5Ltr/Gal Spill Free Mouth • Dermatologically tested • With two antibacterial agents – Chlorhexidine & lactic acid sanitizing action. Item Code. 1031</p> <p>صابون غسيل للأيدي مضاد للبكتيريا سيكورجيم ٥ لتر</p> <p>سيكورجيم خالٍ من العطور المضادة للبكتيريا • ٥ لتر/جالون خالٍ من الانسكابات بالفم • تم اختياره من قبل أطباء الجلدية مع عاملين مضادين للبكتيريا – الكلورهيكسيدين وحمض اللاكتيك، يعملان على التطهير. رمز الصنف. ١٣٠١</p>



Liquid Soap for Hand

Code	Packing	Description
SN012	2 x 5Ltrs	<p>For use on Hand</p> <p>• Karite (Shea Butter) Fragranced. 5Ltr/Gal Spill Free Mouth Dermatologically tested With Glycerine and antibacterial agent to Protect and hydrate skin. • pH 5.5, Kind to skin. Item Code. 1050</p> <p>صابون غسيل للأيدي بمعطر - كاريت ٥</p> <p>• الكاريت (زبدة الشيا) المعطرة. ٥ لتر/جالون خالٍ من الانسكاب تم اختياره من قبل أطباء الجلدية باستخدام الجلسرين وعامل مضاد للبكتيريا لحماية وترطيب البشرة. • درجة حموضة ٥,٥، لطيف على البشرة. رمز الصنف. ٥٠١</p>



Dish Washing Liquid Manual

Code	Packing	Description
SN032	2 x 5Ltrs	<p>For use on Dish Wash.</p> <p>• Green lemon Fragranced 5Ltr/Gal Spill Free Mouth. • Cuts through grease • pH neutral products, kind to skin Forms thick, easily-rinsed foam that does not leave streaks • Fresh fragrance that helps remove odours from dishes. Item Code. 1240</p> <p>صابون سائل لغسيل الصحون برائحة الليمون</p> <p>• معطر بالليمون الأخضر ٥ لتر/جالون مضاد للانسكاب بالفم. • منتجات ذات درجة حموضة محايدة، لطيفة على البشرة، تشكل رغوة سميكة وسهلة الشطف ولا تتكون ترك خلووط. • عطر منعش يساعد على إزالة الروائح الكريهة من الأطباق. رمز الصنف. ٥٢١</p>



Dishwashing Liquid Manual Concentrated

Code	Packing	Description
SN034	2 x 5Ltrs	<p>For use on Dish Wash</p> <p>• Concentrated With Lactic Acid 5Ltr/Gal Spill Free Mouth. • pH neutral product, kind to skin • Sanitizing Forms thick, easily-rinsed foam that does not leave streaks • Fresh fragrance that helps remove odours from dishes. • Item Code 1276</p> <p>صابون سائل لغسيل الصحون مركز بحمض اللكتيك</p> <p>• مركّز بحمض اللاكتيك ٥ لتر/جالون مضاد للانسكاب بالفم. • منتج ذو درجة حموضة محايدة، لطيف على البشرة. • يشكل التعقيم رغوة سميكة وسهلة الشطف ولا تتكون ترك خلووط. • عطر منعش يساعد على إزالة الروائح الكريهة من الأطباق. • رمز الصنف ٦٧٢١</p>



Dishwashing Liquid Concentrated		
Code	Packing	Description
SN037	2 x 5Ltrs	<p>For Use on Dish wash</p> <p>Lemon fragranced 5Ltr/Gal Spill Free Mouth • pH neutral product Kind to skin Forms thick easily-rinsed foam that does not leave streaks • Fresh fragrance that helps remove odours from dishes. Item Code. 1270</p> <p>صابون سائل لغسيل الصحون مركز برائحة الليمون</p> <p>ليمون معطر ٥ لتر/جالون خال من الانسكابات بالفم • منتج محايد لدرجة الحموضة لطيف على البشرة يشكل رغوة سميكة سهلة الشطف ولا تترك خطوطًا. • عطر منعش يساعد على إزالة الروائح الكريهة من الأطباق. رمز الصنف. ٠٧٢١</p>



Glass Cleaner, Mirror and Multi Purpose Cleaner Crystal 750ml		
Code	Packing	Description
SN059	750 ML	<p>For use on Mirror & Multi Purpose</p> <p>Leaves surfaces clean and shiny with no streaks • Perfect for glass surfaces, mirrors and chrome finish Leaves the room pleasantly fragranced. Item code: 1866 S</p> <p>منظف الزجاج والمرآيا والكريستال</p> <p>يترك الأسطح نظيفة ولامعة بدون أي خطوط • مثالي للأسطح الزجاجية والمرآيا والطلاء بالكروم ويترك الغرفة معطرة بشكل لطيف. رمز الصنف: ٦٦٨١ س</p>



Oven & Grill Cleaner Foam		
Code	Packing	Description
SN015	2 x 5Ltrs	<p>For use on Oven & Grill Cleaner</p> <p>• Foam Super Concentrated Fomnonet 5Ltr/Gal Spill Free Mouth • Easily removes grease, oil and burnt-on food residue</p> <p>Forms a thick foam that clings to vertical walls for greater cleaning power even in hard to reach areas Container with foaming nozzle that reduces • product vaporization. Item Code: 1961</p> <p>منظف للأفران والجريل مركز</p> <p>• رغوة فورونيت مركزة للغاية ٥ لتر/جالون خالية من الانسكابات بالفم • يزيل الشحوم والزيوت وبقايا الطعام المحروقة بسهولة بشكل رغوة سميكة تلتصق بالجدران الرأسية للحصول على قوة تنظيف أكبر حتى في المناطق التي يصعب الوصول إليها حاوية ذات فوهة رغوية تقلل من تبخر المنتج. رمز السلعة: ١٦٩١</p>



Machine Dishwash Concentrated		
Code	Packing	Description
SN049	15 Litres	<p>Ideal for automatic dosing. Suitable for use in all makes of commercial dishwashers</p> <p>Alkaline Based For Hard water, Stovil Ultra 15ltr • Detergent: easily removes grease and food residue, • Sequestering action: prevents formation of streaks and limescale on dishes and in the machine. Easily-rinsed foamfree product. Item Code. 1144 •</p> <p>صابون سائل لغسالات الاطباق ذو قاعدة قلووية</p> <p>قاعدة قلووية للمياه العسرة، ستوفيل الترا ٥١ لتر • منظف: يزيل الشحوم والطعام بسهولة ببقايا، • إجراء عزل يمنع تكون الخطوط والترسبات الجيرية على الأطباق وفي آلة. • يلمع الفولاذ: القدرور والمقالي لامعة بدون خطوط أو بقع ماء الحماية التشطية: تمنع تكون الترسيبات الكلسية في غسالة الأطباق منتج خالي من الرغوة سهل الشطف. رمز الصنف. ٤٤١١</p>



Machine Dishwash Rinse Hard water Concentrated		
Code	Packing	Description
SN050	15 Litres	<p>Ideal for automatic dosing. Suitable for use in all makes of commercial dishwashers</p> <p>• Brill Ultra 15ltr, Rapid drying: speeds up drying, works on plastic too • Anti-streak: low-foaming, easily-rinsed for gleaming dishes without streaks and water marks Glass protector: neutralizes caustic residues that ruin glass Odour removing: helps remove foul odours. ItemCode. 1153</p> <p>سائل للشطف بغسالات الأطباق مركز</p> <p>• بريل الترا ٥١ لتر، تجفيف سريع: يسرع عملية التجفيف، ويعمل على البلاستيك أيضًا • مضاد للخطوط: منخفض الرغوة، يمكن شطفها بسهولة للحصول على أطباق لامعة بدون خطوط وعلامات مائية • وافي الزجاج: يجيد المواد الكاوية البقايا التي تقصد الزجاج إزالة الراحة: يساعد على إزالة الروائح الكريهة. رمز الصنف. ٣٥١١</p>



Oven & Grill Cleaner Foam Super Concentrated Spray Fornonet 750ml

Code	Packing	Description
SN051	750 ML  MADE IN ITALY	<p>For use on Oven & Grill Cleaner</p> <p>Easily removes grease, oil and burnt-on food residue • Forms a thick foam that clings to vertical walls for greater cleaning power even in hard to reach areas • Container with foaming nozzle that reduces product vaporization • Code. 1960-S</p> <p>منظف للأفران والجريل مركز</p> <p>يزيل الشحوم والزيوت وبقايا الطعام المحروقة بسهولة. • يشكل رغوة سميكة تلتصق بالجدران العمودية قوة تنظيف أكبر حتى في المناطق التي يصعب الوصول إليها. • حاوية مزودة بفوهة رغوية يقلل من تبخر المنتج. الكود: ١٩٦٠-س</p>



Silver Tarnish Dip Remover

Code	Packing	Description
SN052	2 x 5Ltrs  MADE IN ITALY	<p>For use on</p> <p>• Quickly removes black tarnish from silver • Removes tarnish by simple dipping with no need to polish • Leaves surfaces gleaming. Item Code: 1881</p> <p>مزيل صفل الفضة</p> <p>• يزيل بسرعة تشويه الأسود من الفضة • يزيل تشويه عن طريق غمس بسيط دون الحاجة إلى تلميع • يترك الأسطح لامعة. رمز السلعة: ١٨٨١</p>



Disinfectant with Bactericidal & Fungicidal Action

Code	Packing	Description
SN054	2 x 5Ltrs  MADE IN ITALY	<p>Fresh Pine fragranced, gets rid of bad odours, does not damage metals or mark surfaces and • leaves a pleasant fragrance in the room. • Concentrated disinfectant cleaner • Removes germs and bacteria from all surfaces. • Disinfects, cleans and deodorizes environment and objects. Item Code. 1541</p> <p>مطهر للجراثيم والفطريات برائحة الصنوبر</p> <p>انسكاب الفم • يزيل بسرعة تشويه الأسود من الفضة • يزيل تشويه عن طريق غمس بسيط دون الحاجة إلى تلميع • يترك الأسطح لامعة. رمز السلعة: ١٥٤١</p>



Disinfectant with Bactericidal & Fungicidal Action

Code	Packing	Description
SN055	2 x 5Ltrs  MADE IN ITALY	<p>Fresh Lime fragranced, gets rid of bad odours, does not damage metals or mark surfaces and • leaves a pleasant fragrance in the room. • Concentrated disinfectant cleaner • Removes germs and bacteria from all surfaces. • Disinfects, cleans and deodorizes environment and objects. Item Code. 1544</p> <p>مطهر للجراثيم والفطريات برائحة الصنوبر</p> <p>معطر بالليمون المنعش، يتخلص من الروائح الكريهة، لا يضر المعادن ولا يترك أثراً على الأسطح • يترك رائحة طيبة في الغرفة. • منظف ومطهر مركز. • يزيل الجراثيم والبكتيريا من جميع الأسطح. • يطهر وينظف ويزيل الروائح الكريهة من البيئة والأشياء. رمز الصنف: ١٥٤١</p>



Hard Surface Floor Cleaner

Code	Packing	Description
SN024	2 x 5Ltrs  MADE IN ITALY	<p>For use on Floors</p> <p>Orange fragranced, Spill Free Mouth. • Slightly Alkaline concentrated product with excellent degreasing power, • Removes all kinds of dirt. • No rinse, leaves no streaks</p> <p>Item Code. 1435</p> <p>منظف الأسطح الصلبة برائحة البرتقال</p> <p>معطر بالبرتقال، فم خال من الانسكاب. • منتج قلوي قليل التركيز ذو قدرة ممتازة على إزالة الشحوم. • يزيل جميع أنواع الأوساخ. • لا يشطف، ولا يترك أي خطوط. رمز الصنف: ١٤٣٥</p>



Hard Surface Floor Cleaner

Code	Packing	Description
SN025	2 x 5Ltrs  MADE IN ITALY	<p>For use on Floors Lavender fragranced, 5Ltr/Gal Spill Free Mouth. • Slightly Alkaline concentrated product with excellent degreasing power, • Removes all kinds of dirt. • No rinse, leaves no streaks Item Code. 1436</p> <p>منظف الأضيات الصلبة برائحة اللافندر معطر باللافندر، ٥ لتر/جالون خال من الانسكاب. • منتج قلوي قليل التركيز ذو قدرة ممتازة على إزالة الشحوم. • يزيل جميع أنواع الأوساخ. • لا يشطف، ولا يترك أي خطوط. رمز الصنف. ٦٣٤١</p>



Hard Surface Floor Cleaner

Code	Packing	Description
SN026	2 x 5Ltrs  MADE IN ITALY	<p>For use on Floors Green Apple fragranced, 5Ltr/Gal Spill Free Mouth. • Slightly Alkaline concentrated product with excellent degreasing power, • Removes all kinds of dirt. • No rinse, leaves no streaks. Item Code. 1437</p> <p>منظف الأضيات الصلبة برائحة التفاح الأخضر معطر بالتفاح الأخضر، ٥ لتر/جالون خال من الانسكاب. • منتج قلوي قليل التركيز ذو قدرة ممتازة على إزالة الشحوم. • يزيل جميع أنواع الأوساخ. • لا يشطف، ولا يترك أي خطوط. رمز الصنف. ٧٣٤١</p>



Hard Surface Floor Cleaner

Code	Packing	Description
SN027	2 x 5Ltrs  MADE IN ITALY	<p>For use on Floors Mint & Lemon fragranced, 5Ltr/Gal Spill Free Mouth. • Slightly Alkaline concentrated product with excellent degreasing power • Removes all kinds of dirt. • No rinse, leaves no streaks. Item Code. 1410</p> <p>منظف الأضيات الصلبة برائحة النعناع والليمون معطر بالتفاح الأخضر، ٥ لتر/جالون خال من الانسكاب. • منتج قلوي قليل التركيز ذو قدرة ممتازة على إزالة الشحوم. • يزيل جميع أنواع الأوساخ. • لا يشطف، ولا يترك أي خطوط. رمز الصنف. ٧٣٤١</p>



Hard Surface Floor Cleaner

Code	Packing	Description
SN028	2 x 5Ltrs  MADE IN ITALY	<p>For use on Floors Peach fragranced, 5Ltr/Gal Spill Free Mouth. • Slightly Alkaline concentrated product with excellent degreasing power, • Removes all kinds of dirt. • No rinse, leaves no streaks. Item Code. 1439</p> <p>منظف الأضيات الصلبة برائحة الخوخ معطر بالخبوخ، ٥ لتر/جالون خال من الانسكاب. • منتج قلوي قليل التركيز ذو قدرة ممتازة على إزالة الشحوم. • يزيل جميع أنواع الأوساخ. • لا يشطف، ولا يترك أي خطوط. رمز الصنف. ٩٣٤١</p>



Hard Surface Cleaner

Code	Packing	Description
SN029	2 x 5Ltrs  MADE IN ITALY	<p>For use on Marble, venetian,terrazzo, Palladian and paraquet, delicate surfaces Peach fragranced, 5Ltr/Gal Spill Free Mouth. • Slightly Alkaline concentrated product with excellent degreasing power, • Removes all kinds of dirt. • No rinse, leaves no streaks. Item Code. 1439</p> <p>منظف الأسطح الصلبة للإستخدام على الأسطح الرقيقة من الرخام والبندقية والتيرازو وبالاديان والباراكيه معطر بالخبوخ، ٥ لتر/جالون خال من الانسكاب. • منتج قلوي قليل التركيز ذو قدرة ممتازة على إزالة الشحوم. • يزيل جميع أنواع الأوساخ. • لا يشطف، ولا يترك أي خطوط. رمز الصنف. ٩٣٤١</p>



Hard Surface Floor Cleaner

Code	Packing	Description
SN030	2 x 5Ltrs	<p>For use on Floors</p> <p>Pine fragrancd, 5Ltr/Gal Spill Free Mouth. • Suitable for all types of surfaces, leaves no streak. • With molecular odor eliminator, helps remove foul odor leaving long lasting fragrance</p> <p>Perfect for high traffic public environments. Item Code: 1895</p> <p>منظف الأسطح والأرضيات الحساسة القابلة للغسل كالرخام والباركية</p> <p>معطر بالصنوبر، ٥ لتر/جالون خال من الانسكابات للقم. • مناسب لجميع أنواع الأسطح، ولا يترك أي خطوط. • مع مزيل الرائحة الجزيئي، يساعد على إزالة الرائحة الكريهة ويترك رائحة تدوم طويلا مثالية للبيئات العامة ذات حركة المرور العالية. رمز الصنف: ٥٩٨١</p>



Hard Surface Floor Cleaner

Code	Packing	Description
SN030	2 x 5Ltrs	<p>For use on Floors</p> <p>Lemon fragrancd, 5Ltr/Gal Spill Free Mouth. • Suitable for all types of surfaces, leaves no streak. • With molecular odor eliminator, helps remove foul odor leaving long lasting fragrance</p> <p>• Perfect for high traffic public environments. Item Code: 1897</p> <p>منظف الأضيات الصلبة برائحة الصنوبر</p> <p>معطر بالليمون، ٥ لتر/جالون خال من الانسكاب. • مناسب لجميع أنواع الأسطح، ولا يترك أي خطوط. • مع مزيل الرائحة الجزيئي، يساعد على إزالة الرائحة الكريهة ويترك رائحة تدوم طويلا مثالية للبيئات العامة ذات حركة المرور العالية. رمز الصنف: ٧٩٨١</p>



Hard Surface Floor Cleaner and Degreaser

Code	Packing	Description
SN035	2 x 5Ltrs	<p>For use on Floors</p> <p>Green Power fragrancd, 5Ltr/Gal Spill Free Mouth. • Ideal for all types of washable, water-resistant floors Slightly alkaline concentrated product with excellent degreasing power, removes all kinds of dirt. Item Code: 3105</p> <p>منظف الأضيات الصلبة ومزيل الدهون برائحة القوة الخضراء</p> <p>معطر جرين باور، ٥ لتر/جالون خال من الانسكاب. • مثالية لجميع أنواع قابلة للغسل ومقاومة للماء الأرضيات منتج قلوي قليل التركيز ذو قوة ممتازة لإزالة الشحوم، يزيل جميع أنواع الأوساخ. رمز الصنف: ٥٠١٢</p>



Floor Polish Metalized

Code	Packing	Description
SN033	2 x 5Ltrs	<p>For use on Floors</p> <p>With high cross linked polymers for High Traffic 5Ltr/Gal Spill Free Mouth</p> <p>High-shine self-polishing emulsion suitable for all floors • The protective film is highly resistant to traffic and has an anti-slip and dirt repellent effect. Item Code: 1610</p> <p>ملمع أرضيات بالبوليمر للأماكن كثير الحركة</p> <p>مع بوليمرات عالية الارتباط من أجل حركة مرور عالية ٥ لتر/جالون خالية من الانسكابات مستحلب تلميع ذاتي عالي اللمعان مناسب لجميع الأرضيات • الطبقة الواقية شديدة المقاومة لحركة المرور وله تأثير مضاد للانزلاق والأوساخ. رمز الصنف: ٠١٦١</p>



Floor Wax Remover Water Based

Code	Packing	Description
SN036	2 x 5Ltrs	<p>For use on Floors</p> <p>5Ltr/Gal Spill Free Mouth, • Easily removes protective film from waxed floors. • Safe on all types of hard, water-resistant floors has an anti-slip and dirt repellent effect. Item Code: 1660</p> <p>مزيل شمع الأرضيات ذو أساس مائي</p> <p>٥ لتر/جالون من الفم المقاوم للانسكاب، • يزيل الطبقة الواقية من الشمع بسهولة طوابق. • آمن على جميع أنواع الأرضيات الصلبة والمقاومة للماء وله تأثير مضاد للانزلاق وطارد للأوساخ. رمز الصنف: ٠٦٦١</p>



Degreaser Ultra Multisurface

Code	Packing	Description
SN044	2 x 5Ltrs  MADE IN ITALY	<p>For Stubborn Grime Alkaline based French fragranced • Mouth High-concentration fragranced alkaline degreaser. Effectively removes grease, oil and burnt-on residue, • Ideal for restaurants and catering, industry workshops, offices, warehouses, hospital and nautical sector • pleasant fragrance in the environment • Item Code: 1809</p> <p>مزيل الشحوم العنيد برائحة مرسيليا معطر فرنسي • مزيل الشحوم القلوي المعطر عالي التركيز للقم. يزيل الشحوم والزيوت والمخلفات المحروقة بشكل فعال، • مثالي للمطاعم وورش الصناعة والمكاتب والمستودعات والمستشفيات والقطاع البحري • رائحة لطيفة في البيئة • رمز الصنف: ٩٠٨١</p>



Degreaser Ultra Multisurface

Code	Packing	Description
SN045	2 x 5Ltrs  MADE IN ITALY	<p>For Stubborn Grime Alkaline based Lemon fragranced • Mouth High-concentration fragranced alkaline degreaser. Effectively removes grease, oil and burnt-on residue, • Ideal for restaurants and catering, industry workshops, offices, warehouses, hospital and nautical sector • fragrance in the environment • Item Code: 1801</p> <p>مزيل الشحوم العنيد برائحة الليمون الليمون المعطر • القم مزيل الشحوم القلوي المعطر عالي التركيز. يزيل الشحوم والزيوت والمخلفات المحروقة بشكل فعال، • مثالي للمطاعم والمطاعم وورش الصناعة والمكاتب والمستودعات والمستشفيات والقطاع البحري • العطر في البيئة • رمز الصنف: ١٠٨١</p>



Acid Lime Scale Remover

Code	Packing	Description
SN039	2 x 5Ltrs  MADE IN ITALY	<p>For Machine Dishwasher Spill Free Mouth • Concentrated formula rapidly removes greasy dirt and limescale build-up • Used regularly, it helps equipment perform consistently and increases lifespan • With low-foaming surfactants for excellent rinsing. Item Code: 1950</p> <p>مزيل الترسبات الحمضية لغسالة الأطباق قم خال من الانسكاب • تركيبة مركزة تزيل الدهون بسرعة تراكم الأوساخ والرواسب الجيرية • يُستخدم بانتظام، فهو يساعد المعدات على الأداء بشكل متسق ويزيد من العمر الافتراضي. • مزود بمواد خافضة للتوتر السطحي منخفضة الرغوة لشطف ممتاز. رمز السلعة: ٥٩١</p>



Leather Neutral Cleaner Spray S4 500 ml

Code	Packing	Description
SN060	500 ML  MADE IN ITALY	<p>For use on Leather Eliminates dirt and stubborn marks without leaving residue. • Formula enriched with natural waxes, cleans, nourishes and revives, leaving a soft feel and helping maintain the original look and feel of leather Nourishes natural leather • Safe on treated surfaces Item Code. 1835</p> <p>منظف بخاص للجلد يزيل الأوساخ والعلامات العنيدة دون ترك بقايا. • تركيبة غنية بالشموع الطبيعية، تنظف وتغذي وتنشط، وترتك ملمسًا ناعمًا وتساعد في الحفاظ على الشكل والملمس الأصليين جلد يغذي الجلد الطبيعي • آمن على الأسطح المعالجة رمز الصنف. ٥٣٨١</p>



Carpet, Rugs, fabric Cleaner

Code	Packing	Description
SN046	2 x 5Ltrs  MADE IN ITALY	<p>For use on Carpet, Rugs, fabric Cleaner Concentrate Alkaline Based 5Ltr/Gal Spill Free Mouth. • Removes dirt thoroughly and effectively • Protects fabric colour and structure Leaves the room pleasantly fragranced • Use with an injection/extraction machine. Item Code: 1450</p> <p>للاستخدام على السجاد والبسط ومنظف الأقمشة تركيز على أساس قلوي ٥ لتر/جالون خال من الانسكابات. • يزيل الأوساخ بشكل كامل وفعال. • يجمي لون القماش وينبته ويترك الغرفة معطرة بشكل لطيف • استخدم مع آلة الحقن / الاستخراج. رمز الصنف: ٥٤١</p>



Toilet Cleaner & Descaler With Citric & Lactic Acid 750ml

Code	Packing	Description
SN047	750 ML 	<p>Ideal for Toilet & Wash Rooms</p> <ul style="list-style-type: none"> • Gel formula to cling better also to vertical surfaces • Effective at removing limescale and organic dirt. • Bottle with angled nozzle, for quick, easy application even in least visible places <p>Item Code: 1940</p> <p>منظف المراحيض ومزيل الترسبات بحمض الستريك واللاكتيك ٧٥٠ مل مثالية لغرف المراحيض والغسيل فعال في إزالة الترسبات الكلسية والأوساخ العضوية • تركيبة الجل تلتصق بشكل أفضل أيضًا بالأسطح الرأسية • زجاجة ذات فوهة مائلة، لتطبيق سريع وسهل حتى في الأماكن الأقل وضوحًا • رمز الصنف: ٠٤٩١</p>



Machine Dishwashing Liquid Super Concentrated - WASH T1

Code	Packing	Description
SN041	2 x 5Ltrs 	<p>Use with Trilogy Dozing Unit for best performance & Cost Saving Results.</p> <p>Wash T1 Excellent specific cleaning power for removal of greasy and burnt-on grime and food residues. Product to be used in combination with Trilogy Boost T2 (sequestering action) and Trilogy Rinse T3 (acid rinse aid). Separate components allow optimised dosing set according to water hardness and degree of soil. Does not contain phosphorus or EDTA. Item Code: 4012</p> <p>سائل غسيل لغسالات الأطباق فائق التركيز Wash T1 قوة تنظيف محددة ممتازة لإزالة الأوساخ الدهنية والمحتربة وبقايا الطعام. يستخدم المنتج مع boost t2 Trilogy (عمل الغزل) و3T Rinse Trilogy (مساعدة الشطف الحمضي). تتيح المكونات المنفصلة ضبط الجرعات بشكل مثالي وفقا لصلابة الماء ودرجة التربة. لا يحتوي على الفوسفور أو Edta. رمز الصنف: ٢١٠٤</p>



Machine Dishwashing Liquid Super Concentrated - BOAST T2

Code	Packing	Description
SN042	2 x 5Ltrs 	<p>Use with Trilogy Dozing Unit for best performance & Cost Saving Results.</p> <p>Boast T2 Excellent sequestering power, prevents formation of lime scale during the washing phase Product to be used in combination with Trilogy Wash T1 (deter-gent action) and Trilogy Rinse T3 (acid rinse aid). Separate components allow optimised dosing set according to water hardness and degree of soil. Does not contain phosphorus or EDTA. Item Code: 4013</p> <p>سائل غسيل لغسالات الأطباق فائق التركيز يتميز بقوة عزل ممتازة 2t، ويمنع تكون الترسبات الكلسية أثناء مرحلة الغسيل. يمكن استخدام المنتج مع الغسل الثلاثي 1t (مفعول منظف) والشطف 3t (مساعدة الشطف الحمضي). تتيح المكونات المنفصلة ضبط الجرعات بشكل مثالي وفقا لصلابة الماء ودرجة التربة. لا يحتوي على الفوسفور أو Edta. رمز الصنف: ٢١٠٤</p>



Machine Dishwashing Liquid Super Concentrated - RINSE T3

Code	Packing	Description
SN043	2 x 5Ltrs 	<p>Use with Trilogy Dozing Unit for best performance & Cost Saving Results.</p> <p>Rinse T3 Excellent drying power, low-foaming system for dishes without streaks and water marks Product to be used in combination with Trilogy Wash T1 (deter-gent action) and Trilogy Boost T2 (sequestering action). Separate components allow optimised dosing set according to water hardness and degree of soil. Does not contain phosphorus or EDTA. Item Code: 4014</p> <p>سائل غسيل لغسالات الأطباق فائق التركيز ثلاثي الشطف شطف 3T قوة تجفيف ممتازة، نظام رغوة منخفضة للأطباق بدون خطوط وعلامات مائية. المنتج يستخدم مع ثلاثية الغسل 1T (مفعول منظف) وثلاثية تعزيز 2T (مفعول الغزل). تتيح المكونات المنفصلة ضبط الجرعات بشكل مثالي وفقا لصلابة الماء ودرجة التربة. لا يحتوي على الفوسفور أو Edta. رمز الصنف: ٤١٠٤</p>



Drain Opener Gel 1 Litre

Code	Packing	Description
SN023	1 Litre 	<p>For use on wood, formica and plastics.</p> <p>Powerful Alkaline Based With Active Chlorine.</p> <p>Item Code: 1979 S</p> <p>جل فتاحة الصرف ١ لتر للاستخدام على الخشب والفورميكا والبلاستيك. قلوي قوي يعتمد على الكلور النشط. رمز الصنف: ٩٧٩١ س</p>



Industrial Hand Liquid Soap

Code	Packing	Description
SN009	2 x 5Ltrs  MADE IN ITALY	<p>For use on Hands</p> <p>Heavy Duty Liquid Soap with Micro beads Ideal for removing stubborn grime and grease from the engineering, steel, chemical industry, etc. • Orange scent, leaves hands pleasantly fragrant.</p> <p>• Powerful emulsifying of mechanical oil and grease Item Code: 1045</p> <p>صابون منظف للأيدي صناعي</p> <p>صابون سائل عالي التجميل مع خرزات صغيرة مثالي لإزالة الأوساخ والشحوم العنيدة من الصناعات الهندسية والصلب والصناعات الكيماوية وما إلى ذلك. • رائحة البرتقال، تترك الأيدي معطرة بشكل ممتع.</p> <p>• استحلاب قوي للزيوت والشحوم الميكانيكية رقم الصنف: ٥٤٠١</p>



Disinfectant Concentrated Cleaner

Code	Packing	Description
SN053	2 x 5Ltrs  MADE IN ITALY	<p>For use on Public bathroom, Clinics & Hospitals</p> <p>• Concentrated disinfectant cleaner has fungicidal, bactericidal and virucidal action, killing gram positive and gram negative bacteria, fungus. • Particularly suitable for disinfecting surfaces and equipment in the agrifood, hotel and catering sector. • It is also suitable for busy areas like public bathrooms, clinics and hospital areas. • Gets rid of 99.9% of bacteria, mould and viruses. Item Code: 1511</p> <p>• المنظف المطهر المركز له تأثير مبيد للفطريات والبكتيريا والفيروسات، حيث يقتل البكتيريا ايجابية الجرام وسالبة الجرام والفطريات. • مناسبة بشكل خاص لتطهير الأسطح والمعدات في قطاع الأغذية الزراعية والفنادق والمطاعم.</p> <p>• كما أنها مناسبة للمناطق المزدحمة مثل الحمامات العامة والعيادات ومناطق المستشفيات. • يتخلص من ٩٩,٩٩% من البكتيريا والعفن والفيروسات. رمز الصنف: ١١٥١</p>



Deo Fresh Lavender Fragrance 750ml

Code	Packing	Description
SN005	750 ML  MADE IN ITALY	<p>Fragrance With Odour Eliminator Technology • Suitable for fragrance areas With molecular odour eliminator, helps remove foul odours leaving long-lasting fragrance • Suitable for hotel rooms, bathrooms, salons, kitchens, car interiors, shoe racks, closets, animal beds, carpets and fabrics, bins, carpets and rugs • Does not leave residue • Item Code: 1903 S</p> <p>معطر ديو فريش برائحة اللافندر</p> <p>عطر مزود بتقنية مزيل الرائحة • مناسب للمناطق العطرية مع مزيل الرائحة الجزئي، يساعد على إزالة الروائح الكريهة ويترك رائحة تدوم طويلا • مناسب لغرف الفنادق والحمامات والصالونات والمطابخ والديكورات الداخلية للسيارات ورفوف الأحذية والخزائن وأسرة الحيوانات والسجاد والأقمشة والصدانق والسجاد والموكيت • لا يترك بقايا • رمز الصنف: ٣٠٩١</p>



Deo Fresh Musk Fragrance 750ml

Code	Packing	Description
SN006	750 ML  MADE IN ITALY	<p>Fragrance With Odour Eliminator Technology • Suitable for fragrance areas With molecular odour eliminator, helps remove foul odours leaving long-lasting fragrance • Suitable for hotel rooms, bathrooms, salons, kitchens, car interiors, shoe racks, closets, animal beds, carpets and fabrics, bins, carpets and rugs • Does not leave residue • Item Code: 1890 S</p> <p>معطر ديو فريش برائحة المسك</p> <p>عطر مزود بتقنية مزيل الرائحة • مناسب للمناطق العطرية مع مزيل الرائحة الجزئي، يساعد على إزالة الروائح الكريهة ويترك رائحة تدوم طويلا • مناسب لغرف الفنادق والحمامات والصالونات والمطابخ والديكورات الداخلية للسيارات ورفوف الأحذية والخزائن وأسرة الحيوانات والسجاد والأقمشة والسلال والسجاد والموكيت • لا يترك بقايا • رمز الصنف: ٠٩٨١</p>



Urinal Screen Uri Deo Fragrance

Code	Packing	Description
SN007	EACH  MADE IN ITALY	<p>The new deodorising urinal screen releases 10 times more fragrance in one month. • Revolutionary design: more flexible, fits all types of urinal; coloured: to allow perfect visibility of the WC; allows urine to drain easily. Its special action releases "beneficial particles" that eliminate urine odour and it runs out gradually as the fragrance evaporates. Item Code: 2431</p> <p>تطلق شاشة المبوالة الجديدة لإزالة الروائح الكريهة ١٠ أضعاف العطر في شهر واحد. • تصميم ثوري: أكثر مرونة، ويتناسب جميع أنواع المبوالة. ملونة: للسماح برؤية مثالية للمرحاض؛ يسمح بتصريف البول بسهولة. تعمل مفعوله الخاص على إطلاق «جزيئات مفيدة» تقضي على رائحة البول وتتفد تدريجياً مع تبخر العطر. رمز الصنف: ١٣٤٢</p>



Urinal Tablets Uri Tabs 3Kg

Code	Packing	Description
SN008	BUCKET  MADE IN ITALY	Odour Eliminating Disappearing • Urinal Cleaning Tabs With Biological Activators Slow-dissolving tabs to eliminate and prevent formation of urine scale. • Easy to use, guaranteed long-term action. • Eliminates foul odours and leaves the environment pleasantly fragranced. Item Code: 2150 أقراص تنظيف البول إزالة الرائحة الكريهة • أقراص تنظيف البول باستخدام المنشطات البيولوجية أقراص بطيئة الذوبان للقضاء على تقشر البول ومنع تكوينه. • سهل الاستخدام، ومضمون العمل على المدى الطويل. • يزيل الروائح الكريهة ويترك البيئة معطرة بشكل لطيف. رمز الصنف: ٥١٢



Toilet Cleaner & Descaler Gel Sani Citric 1 Litre 1ltr

Code	Packing	Description
SN013	1 Litre  MADE IN ITALY	• Citric Acid Based Cleaner & Descaler Gel For Daily Cleaning Of WCs & Bathroom. • Perfect for routine cleaning • Effectively removes lime scale Gel formula to cling better also to vertical surfaces. • Bottle with angled nozzle, for quick, easy application even in least visible places. Item Code 1913-5 جل منظف ومزيل الترسبات للحمامات • منظف وجل مزيل للرواسب يحتوي على حمض الستريك للتنظيف اليومي للمراحيض والحمامات. • مثالي للتنظيف الروتيني. • يزيل بشكل فعال الترسبات الكلسية بتركيبه جل لتلتصق بشكل أفضل أيضاً بالأسطح الرأسية. • زجاجة ذات فوهة مائلة، لتطبيق سريع وسهل حتى في الأماكن الأقل وضوحاً. رمز الصنف ٣١٩١



Degreaser Foam Alkaline Based - 15 Litre

Code	Packing	Description
SN021	DRUM  MADE IN ITALY	Emulsi Foam 15ltr Alkaline Foam, Degreaser Foaming alkaline detergent with high level of alkalinity and surfactants Particularly effective in removing all heavy soil including fatty amides and greasy proteins Foam formula that also clings perfectly to vertical walls, equipment, workbenches and floors .Ideal in meat, fish and vegetable processing and the agri food industry in general Item Code: 1852 مزيل رغوي قوي للشحوم الصعبة رغوة مستحلب ٥١ لتر رغوة قلوية، منظف قلوي رغوي مع مستوى عال من القلوية والمواد الخافضة للتوتر السطحي فعال بشكل خاص في إزالة جميع التربة الثقيلة بما في ذلك الأميدات الدهنية والبروتينات الدهنية تركيبة رغوية تلتصق أيضاً بشكل مثالي بالجدران الرأسية والمعدات ومقاعد العمل والأرضيات مثالية في اللحوم والأسماك وتجهيز الخضروات وصناعة الأغذية الزراعية بشكل عام. رمز الصنف: ٢٥٨١



Detergent Cleaner Alkaline based - 15 Litre

Code	Packing	Description
SN061	DRUM  MADE IN ITALY	Non Foaming - Emulsi Cip 15ltr Non Foaming alkaline detergent with high level of alkalinity and surfactants • Particularly effective in removing all heavy soil including fatty amides and greasy proteins. • Ideal in food industry, agriculture, dairy & cheese industry, meat, fish and vegetable processing and the agrifood industry in general • Item Code: 2142 منظف قلوي غير رغوي غير رغوي - مستحلب مستحلب ٥١ لتر منظف قلوي غير رغوي ذو مستوى عال من القلوية والمواد الخافضة للتوتر السطحي • فعال بشكل خاص في إزالة كافة الأتربة الثقيلة بما في ذلك الأميدات الدهنية والبروتينات الدهنية. • يتم شطفها بسهولة، وهي مثالية للاستخدام مع أنظمة التنظيف المكناني والغمر الأوتوماتيكية وأنظمة الضغط المنخفض. • مثالية في الصناعات الغذائية والزراعة وصناعة الألبان والجبن واللحوم والأسماك والخضروات وصناعة الأغذية الزراعية بشكل عام. رمز الصنف: ٢٤١٢



Quantum Chlor - Stain Remover

Code	Packing	Description
SN002	2 x 5Ltrs  MADE IN ITALY	Concentrated Active Chlorine Based Fabric Bleach Powerful stain remover on most fabrics. • Effective at low temperatures. • Guarantees excellent cleaning Optimised for use with Quantum System products. 5Ltr/Gal Spill Free Mouth. Item Code: 2053 HC كلور منظف ومبيض الأقمشة مركز مبيض الأقمشة المعتمد على الكلور النشط المركز، مزيل قوي للبقع على معظم الأقمشة. • فعال في درجات الحرارة المنخفضة. • يضمن التنظيف الممتاز الأمثل للاستخدام مع منتجات نظام الكم. ٥ لتر/جالون خالٍ من الأنسكاب. رمز الصنف: ٣٥٠٢ هك



Cloro Liquid 15 Litre

Code	Packing	Description
SN003	DRUM 	Liquid Chlorine 14-15% For Treating Pool Water • Effective in shock treatments Can also be used undiluted • Contains strong oxidising ingredients • Item Code. 2082 كلور سائل لمعالجة مياه حمامات السباحة الكلور السائل ١٤-١٥٪ لمعالجة مياه حمامات السباحة • فعال في علاج الصدمات يمكن استخدامه أيضا بدون تخفيف • يحتوي على مكونات مؤكسدة قوية رمز الصنف: ٢٨٠٢



Stain Remover with Active Oxygen

Code	Packing	Description
SN014	500 ML 	• ForOxidizable Stains X1 Oxy 500ML Highly effective on oxidisable stains like tea, coffee, wine, blood, fruit, grass, ice cream, tomato, mould, etc. Reduces percentage of waste and helps increase lifespan of clothes by avoiding continuous rewashing Safe on whites and colours ItemCode. 1814 مزيل البقع بالأوكسجين النشط للبقع القابلة للأكسدة • للبقع القابلة للأكسدة 1X أوكسي ٥٠٠ مل فعال للغاية على البقع القابلة للأكسدة مثل الشاي، القهوة، النبيذ، الدم، الفاكهة، العشب، الأيس كريم، الطماطم، العفن، إلخ. يقلل من نسبة الهدر ويساعد على زيادة عمر الملابس عن طريق تجنبها إعادة الغسيل الم مستمر آمن على الملابس البيضاء والملونة. ٤١٨١



Ph Plus/Ph Corrector

Code	Packing	Description
SN001	DRUM 	Maintaining a correct ideal pH value of 7.2 -7.4 with SW7 -pH+ has various benefits: limits water change due to saturation and reduces running costs added effect of precipitating metals like iron and manganese limits eye irritation. Item code. 2615 pH زائد / مصحح الرقم الهيدروجيني إن الحفاظ على قيمة الرقم الهيدروجيني المثالية الصحيحة البالغة ٧.٢-٧.٤ مع SW7 -PH+ له فوائد مختلفة: يحد من تغير الماء بسبب التشبع ويقلل من تكاليف التشغيل، كما يحد التأثير الإضافي لترسيب المعادن مثل الحديد والمنغنيز من تهيج العين. رمز الصنف: ٥١٦٢



Water Treatment Additive Chlorine Based SW2 Dichlor 56 - Kg 5

Code	Packing	Description
SN004	BUCKET 	Product with highly stabilised isocyanuric acid base Continuous use progressively releases the chlorine stabiliser, slowing breakdown by up to 80%, even in outdoor pools exposed to sun Product dissolves in water in a weakly acidic reaction that helps keep pool water pH stable at optimal value Item Code : 2613 معالجة المياه المضافة القائمة على الكلور SW٢ ديكلور ٥٦ - كجم ٥ المنتج ذو قاعدة حمض الأيزوسيانوريك عالية الثبات، الاستخدام المستمر يطلق مثبت الكلور تدريجياً، مما يبطئ التحلل بنسبة تصل إلى ٨٠٪، حتى في حمامات السباحة الخارجية المعرضة للشمس. يذوب المنتج في الماء في تفاعل حمضي ضعيف يساعد في الحفاظ على درجة حموضة مياه حمام السباحة ثابتة عند القيمة المثالية. الكود : ٢٦١٣



Algae Eliminating in Pool Water SW9 ALGAE 15kg

Code	Packing	Description
SN002	DRUM 	Ensures optimum hygiene conditions because it works on a range of different micro - organism • Prevents algae bloom in the pool and eliminates established algae bloom Item Code. 2604 مزيل الريم والطحالب من مياه حمامات السباحة يضمن ظروف النظافة المثلى لأنه يعمل على مجموعة من الكائنات الحية الدقيقة المختلفة، ويمنع ازدهار الطحالب في حوض السباحة ويقضي على ازدهار الطحالب. ٤٠٦٢



Alcohol-based no-rinse hand disinfectant-600ml

Code	Packing	Description
SN057	600ml  MADE IN ITALY	Alcohol-based no-rinse hand disinfectant Hydroalcoholic disinfectant skin rub, Gets rid of 99.9 % of bacteria, mould and viruses in 60 seconds. With hydrating agents. Can be used in any environment: healthcare, public places, industrial and household. • Item Code. 1035 مطهر لليدين بدون شطف يحتوي على الكحول - ٦٠٠ مل مطهر لليدين يحتوي على كحول لا يشطف، مطهر كحولي مائي لفرك الجلد، يتخلص من ٩٩,٩٩٪ من البكتيريا والعفن والفيروسات في ٠٦ ثانية. مع عوامل الترطيب. يمكن استخدامها في أي بيئة: الرعاية الصحية والأماكن العامة والصناعية والمنزلية. رمز الصنف. ٥٣٠١



Alcohol-based no-rinse hand disinfectant.

Code	Packing	Description
SN058	2 x 5Ltrs  MADE IN ITALY	Alcohol-based no-rinse hand disinfectant Hydroalcoholic disinfectant skin rub, Gets rid of 99.9 % of bacteria, mould and viruses in 60 seconds. With hydrating agents. Can be used in any environment: healthcare, public places, industrial and household. • Item Code. 1036 مطهر لليدين بدون شطف يحتوي على الكحول مطهر لليدين يحتوي على كحول لا يشطف، مطهر كحولي مائي لفرك الجلد، يتخلص من ٩٩,٩٩٪ من البكتيريا والعفن والفيروسات في ٠٦ ثانية. مع عوامل الترطيب. يمكن استخدامها في أي بيئة: الرعاية الصحية والأماكن العامة والصناعية والمنزلية. رمز الصنف. ٦٣٠١



Hand Wash Fragranced Liquid Soap

Code	Packing	Description
SN059	2 x 5Ltrs  MADE IN ITALY	For hands, face and body Dermatologically tested, Cleanses hands, leaving them fresh and clean pH 5.5, kind to skin, With glycerine and antibacterial agent to protect and hydrate skin. Item code. 1050 صابون سائل معطر لغسل اليدين للبيدين والوجه والجسم، تم اختياره من قبل أطباء الجلدية، وينظف اليدين ويتركها منعشة ونظيفة. درجة حموضة ٥,٥. لطيفة على البشرة، مع الجليسرين وعامل مضاد للبكتيريا لحماية وترطيب البشرة. رمز الصنف. ٥١٦٢



Stovil Fast Dual Action Alkaline Dishwashing Liquid

Code	Packing	Description
SN060	2 x 5Ltrs  MADE IN ITALY	Detergent: easily removes grease and food residue Sequestering action: prevents formation of streaks and limescale on dishes and in the machine Shines steel: gleaming pots and pans without streaks or water spots Active Protection: prevents formation of limescale inside the dishwasher Item Code : 1166 ستوفيل فاست سائل غسيل الأطباق القلوي ثنائي المفعول المنظف: يزيل الشحوم ويقيها الطعام بسهولة إجراء العزل: يمنع تكون الخطوط والترسبات الجيرية على الأطباق وفي الجهاز يلمع الفولاذ: الدور والمقالي اللامعة بدون خطوط أو بقع ماء الحماية الفعالة: يمنع تكون الترسبات الجيرية داخل غسالة الأطباق رمز الصنف: ٦٦١١



Non-Foaming Active Chlorine Hard Surface Cleaner

Code	Packing	Description
SN061	2 x 5Ltrs  MADE IN ITALY	Concentrated formula easily removes dirt residue Eliminates unpleasant odours Cleans, freshens and removes stains in one solution Non-foaming formula for easy rinsing Item Code. 1173 منظف الأسطح الصلبة بالكلور النشط غير الرغوي تركيبة مركزة تزيل بقايا الأوساخ بسهولة وتزيل الروائح الكريهة ينظف وينعش ويزيل البقع في محلول واحد، تركيبة غير رغوية لسهولة الشطف رمز الصنف. ٣٧١١



Hydrochloric Acid-Based Cleaner and Descaler for Stubborn Grime

Code	Packing	Description
SN063	2 x 5Ltrs  MADE IN ITALY	Effectively removes inorganic grime like: limescale, saltpeter bloom, cement, plaster, rust... Ideal for thorough washing of floors after laying, like Florentine terracotta, gres and clinker tiles Safe for limescale removal on surfaces. Item Code. 1460. منظف ومزيل لترسبات يعتمد على حمض الهيدروكلوريك للتخلص من الأوساخ العنيدة يزيل بشكل فعال الأوساخ غير العضوية مثل: الرواسب الكلسية، وزهر الملح الصخري، والأسمنت، والجص، والصدأ... مثالي للغسيل الشامل للأرضيات بعد وضعها، مثل بلاط التراكوتا الفلورنسي والجريس والكلنكر آمن لإزالة الترسيبات الكلسية على الأسطح. رمز الصنف. ١٤٦٠



GREKOL SS Unscented alkaline degreaser

Code	Packing	Description
SN064	2 x 5Ltrs  MADE IN ITALY	Concentrated degreaser easily removes dirt Compatible with all surfaces including marble and soft metals like aluminium and copper Unfragranced product, suitable for cleaning all kitchen surfaces and equipment • Item Code. 1036 GREKOL SS مزيل الشحوم القلوي غير المعطر مزيل الشحوم المركز يزيل الأوساخ بسهولة متوافق مع جميع الأسطح بما في ذلك الرخام والمعادن الناعمة مثل الألومنيوم والنحاس منتج غير معطر، مناسب لتنظيف كافة أسطح ومعدات المطبخ رمز الصنف. ١٠٣٦



Multi Activ Disinfectant for Household Cleaning

Code	Packing	Description
SN065	750ml  MADE IN ITALY	Ready-to-use alcohol-based multi purpose disinfectant degreaser. Its antibacterial formula guarantees removal of gram positive and gram negative bacteria, fungi, mould and bad odours from smooth surfaces. MULTI ACTIV®- Handy for disinfecting kitchens, bathrooms and all food codecontact surfaces. Item code. 1821-5 مطهر متعدد الفعالية للتنظيف المنزلي مزيل شحوم مطهر كحولي متعدد الأغراض جاهز للاستخدام. تضمن تركيبته المضادة للبكتيريا إزالة البكتيريا الموجبة والسالبة الجرام والفطريات والعفن والروائح الكريهة من الأسطح المساء. مفيد لتطهير المطابخ والحمامات وجميع المواد الغذائية أسطح الاتصال الرمزية. رمز الصنف. ١٨٢١-٥



SANIALC Quick-Drying Hard Surface Cleaner

Code	Packing	Description
SN066	750ml  MADE IN ITALY	Cleans and degreases without rinsing, Dries rapidly without leaving streaks on surface Based on quaternary ammonium salts and alcohol, Leaves the room pleasantly fragranced. Item code. 1830-5 سانيالك منظف الأسطح الصلبة سريع الجفاف ينظف ويزيل الشحوم دون شطف، ويجف بسرعة دون ترك خطوط على السطح. يعتمد على أملاح الأمونيوم الرباعية والكحول، ويترك الغرفة معطرة بشكل لطيف. رمز الصنف. ١٨٣٠-٥



DEO FRESH - Argan

Code	Packing	Description
SN067	750ml  MADE IN ITALY	Luxuriously fragranced non-aerosol room freshener. Suitable for fragrancing rooms With molecular odour eliminator, helps remove foul odours leaving long-lasting fragrance Also suitable for bins, carpets and rugs, Does not leave residue Item Code. 1893-5 ديو فريش - الأركان معطر غرف معطر بشكل فاخر بدون بخاخ. مناسب للغرف المعطرة مع مزيل الروائح الجزيئي، يساعد على إزالة الروائح الكريهة ويترك رائحة تدوم طويلاً مناسب أيضاً للصناديق والسجاد والموكيت، ولا يترك بقايا رمز الصنف. ١٨٩٣-٥



Detergent Super Concentrated - ECOLABEL		
Code	Packing	Description
SN062	2 x 5Ltrs  MADE IN ITALY	Alkaline based With Sequestering Agents Quantum Basic 5Ltr/Gal Spill Free Mouth. • Increases the alkalinity of the washing water making removal of dirt easier with anti-depositing agents to stop dirt re depositing in the fibres during the wash. • Prevents greying of fabric. • Optimised for use with Quantum System products Item Code: 2051 HC منظف قلوي فائق التركيز قاعدة قلوية مع عوامل عزل خالية من الانسكاب. • يزيد من قلوية ماء الغسيل مما يجعل إزالة الأوساخ أسهل باستخدام عوامل مضادة للترسب لمنع إعادة ترسيب الأوساخ في الألياف أثناء الغسيل. • يمنع شيب القماش. • الأمثل للاستخدام مع منتجات نظام الكم رمز الصنف: ١٥٠٢ HC



Detergent Liquid Washing for Wool And Delicates		
Code	Packing	Description
SN018	2 x 5Ltrs  MADE IN ITALY	• Wooldet 5Ltr/Gal Spill Free Mouth Complete product with surfactants and sequestering agents. • Delicate on fabrics, ideal for washing wool and silk garments. • Can be used with automatic or manual dosing systems. Safe on whites and colours. Item Code: 2030 منظف سائل للصوف والأقمشة الرقيقة انسكاب الفم منتج كامل مع المواد الخافضة للتوتر السطحي وعوامل العزل. • رقيق على الأقمشة، ومثالي لغسل الملابس الصوفية والحريرية. • يمكن استخدامه مع أنظمة الجرعات الأوتوماتيكية أو اليدوية. آمن على الملابس البيضاء والملونة. رمز الصنف: ٢٠٢ HC



Laundry Detergent		
Code	Packing	Description
SN019	2 x 5Ltrs  MADE IN ITALY	• Super Concentrated With Surfactants & Stain Remover - Quantum Surf 5Ltr/Gal Spill Free Mouth Effective removal of greasy and enzymatic dirt Guarantees excellent whiteness. The Proactive System technology stops dirt from redepositing in the fibres and makes removal easier. Optimised for use with Quantum System products. Item Code: 2052HC منظف ومزيل فائق التركيز لبقع للغسيل مركز للغاية مع المواد الخافضة للتوتر السطحي ومزيل البقع - كوانتوم سيرف ٥ لتر/جالون خال من الانسكاب. • إزالة الفعالة للأوساخ الدهنية والإنزيمية مما يضمن بياضًا ممتازًا. تعمل تقنية النظام الاستباقي على منع إعادة ترسب الأوساخ في الألياف وتجعل عملية الإزالة أسهل. الأمثل للاستخدام مع منتجات نظام الكم. رمز الصنف: ٢٥٠٢ HC



Laundry Detergent		
Code	Packing	Description
SN004	2 x 5Ltrs  MADE IN ITALY	With Super Stain Removing, Additives with surfactants & Solvents - Quantum Booster Kg5 Super Stain Removing Laundry Additive Effective at removing greasy dirt, fat, sun creams, spa oils, paint, etc. The Proactive System technology stops dirt from redepositing in the fibres and makes removal easier Optimised for use with Quantum System products. Item Code: 2090HC منظف ومزيل فائق التركيز لبقع للغسيل مع الإزالة الفائقة للبقع، والمواد المضافة مع المواد الخافضة للتوتر السطحي والمذيبات - المعزز الكمي كجم ٥ إضافات الغسيل الفائقة لإزالة البقع فعالة في إزالة الأوساخ الدهنية والدهون وكريمات الشمس وزيوت السبا والطلاء وما إلى ذلك. تمنع تقنية النظام الاستباقي الأوساخ من إعادة ترسيبها في الألياف وتجعلها إزالة أسهل للأمثل للاستخدام مع منتجات نظام الكم. رمز الصنف: ٩٠٢ HC



Total Body Soft Mousse		
Code	Packing	Description
SN068	600ml  MADE IN ITALY	pH neutral skin-cleansing mousse with delicate surfactants for body, hair and intimate washing. Formulated to minimize the risk of allergies, Suitable for all skin types With hyaluronic acid, glycerine, Vitamin E and panthenol. Perfect for daily hygiene and assisted bathing Item Code: 3211 موس ناعم لكامل الجسم موس لتنظيف البشرة ذو درجة حموضة محايدة مع مواد خافضة للتوتر السطحي رقيقة للجسم والشعر والغسيل الحميمي. تم تركيبه لتقليل مخاطر الحساسية، ومناسب لجميع أنواع البشرة مع حمض الهيالورونيك والجلسرين وفيتامين E والبانثينول، مثالي للنظافة اليومية والمساعدة في الاستحمام. ١١٢٢



Spray Foamer

Code	Packing	Description
SN056	EACH  MADE IN ITALY	Professional XL sprayer with 120 cm wand for 5Ltr Gal container Reduces air-borne vapour when used with caustic products like FORNONET - Item Code رش رغوة بخاخ احتراي في مقاس XL بعضا ٠٢١ سم حاوية سعة ٥ لتر تقلل من البخار المحمول بالهواء عند استخدامها مع المنتجات الكاوية مثل فورنوت

Dosing Pump 3 Unit Trilogy Dosing system



Features:-

- With three peristaltic pumps suitable for any type of dishwasher (tunnelhood-utensil washer-single tank).
- Dispenses concentrated dishwashing liquid, booster and rinse aid in proportion to water hardness, degree of soil and dishwasher water consumption: dose measured according to customer requirements. • Exclusive dedicated software with washing statistics storage and processing (no. of cycles, consumption, etc.)
- **Best results can be achieved by using Trilogy Wash T1, Trilogy Boost T2 & Trilogy Rinse T3**

Item Code. 93



Dilution Pump For 4 Types Of Different Liquid



- Automatic doser connected to water supply for simple, quick dilution of product to be used in common cleaning operations.
- Does not require power supply or compressed air.
- Press the button to dispense product at set dilution.
- Various dilution values available to prevent waste.
- Item Code. 91



Code: HLUK01



مجفف غسالة الأواني
Automatic Rinse Aid

Packing : 5Ltrs

Code: HLUK02



منظف متعدد الأغراض
All Purpose Cleaner

Packing : 5Ltrs

Code: HLUK03



منظف ومعقم
Cleaner Sanitizer

Packing : 5Ltrs

Code: HLUK04



منظف الأرضيات وصيانتها
Floor Cleaner & Maintainer

Packing : 5Ltrs

Code: HLUK05



منظف السجاد
Carpet Cleaner

Packing : 5Ltrs

Code: HLUK06



منظف الزجاج
Glass Cleaner

Packing : 1Ltr

Code: HLUK07



سائل غسيل الصحون الأوتوماتيكي
Automatic Dishwasher Liquid

Packing : 20Ltrs

Code: HLUK08



مزيل البقع
Stain Remover

Packing : 1Ltr

Code: STC143



مسحوق امتصاص السوائل - ١,٥ كجم
Absorb Powder - 1.5 kg tub

Packing : EACH

Code: ABI101



Luxury foam soap

Anti Bacterial foam soap

Lemon foam soap

Gardenia foam soap

Rose foam soap

Lavender foam soap

صابون رغوة لليدين - كيس

Hand Foam Soap - Pouch

Packing : 800ml

Code: ABI129

Code: ABI133

Code: ABI136



معقم لليدين - جل

Sanitizer Hand Handi - Gel

Packing : 50ml/350ml/5ltrs ABI136 /129 /133

Code: ABI185



معقم لليدين - سائل

Sanitizer Hand Handi - Liquid

Packing : 4x5Ltrs

Code: ABI107



معقم الأسطح

Sanitizer Surface Ezy

Packing : 625ml

Code: ABI108



معقم الاسطح

Sanitizer Surface Ezy

Packing : 4x5Ltrs

Code: ABI131

MOH-APPROVED



مطهر الفينول

Disinfectant Phenolic

Packing : 4x5Ltrs

Code: ABI105



مطهر ايزي - بخاخ

Disinfectant Ezy Spray

Packing : 500ml

Code: ABI102



مطهر للمستشفيات فيروسايد التتر

Virucide 100 Hospital Disinfectant

Packing : 1x12Liter

Code: ABI141 500ml



مطهر ضد الجراثيم

Disinfectant Antiseptic Ezy

Packing : 500/750ml

Code: ABI135 750ml

Code: ABI138



مطهر ضد الجراثيم

Disinfectant Antiseptic

Packing : 750ml

Code: ABI173



مطهر برائحة الليمون

Disinfectant Lemon

Packing : 750ml

Code: ABI159



مطهر برائحة الصنوبر

Disinfectant Pine

Packing : 4x5 Ltr

Code: ABI166



مطهر الفينول

Disinfectant Phenolic

Packing : 4x5 Ltr

Code: ABI106



حمض الهيبوكلوروس فيروبان

Hypochlorous Acid Viroban

Packing : 4x5Ltrs

Code: ABI104



صابون برغوة للأيدي - لكجري

Soap Hand Foam - Luxury

Packing : 4x5Liters

Code: ABI110



صابون كريم للأيدي - لكجري

Soap Hand Cream - Luxury

Packing : 4x5Ltrs

Code: ABI112



صابون سائل للأيدي - لافندر

Soap Hand Liquid-Lavender

Packing : 4x5Ltrs

Code: ABI113



صابون سائل للأيدي - ليمون

Soap Hand Liquid-Lemon

Packing : 4x5Ltrs

Code: ABI158



سائل صابون لليديين - ورد

Soap Hand Liquid - Rose

Packing : 4x5 Ltr

Code: ABI121



صابون يد برغوة

Soap Hand Foam

Packing : 4x5Ltrs

Code: ABI154



صابون سائل للأيدي مضاد للبكتيريا

Soap Hand Liquid Anti Bacterial

Packing : 4x5Ltrs

Code: ABI169



صابون سائل للأيدي - أريج

Soap Hand Liquid Areej

Packing : 350ml

Code: ABI140



صابون سائل للأيدي

Soap Hand Liquid

Packing : 20Ltrs

Code: ABI116



Premium Quality

Brit ACC



مبيض الغسيل

Bleach Britacc

Packing : 500ml

Code: ABI117



Premium Quality

Brit ACC



مبيض الغسيل

Bleach Britacc

Packing : 3.78Ltrs

Code: ABI146 5 Ltr

Code: ABI142 675ml



منظف متعدد الأغراض

All Purpose Cleaner

Packing : 4x5 Ltr

Code: ABI130



منظف متعدد الأغراض

All Purpose Cleaner

Packing : 25Ltrs

Code: ABI144



منظف متعدد الأغراض

All Purpose Cleaner

Packing : 20Ltrs

Code: ABI132



صابون سائل لغسل الصحون

Dish Washing Liquid Ezy

Packing : 500ml

Code: ABI128



صابون سائل لغسل الصحون

Dish Washing Liquid Ezy

Packing : 1Ltr

Code: ABI152



سائل غسيل الاواني - اونو

Dish Washing Liquid ONO

Packing : 5Ltrs.

Code: ABI174



سائل غسيل الاواني - اونو

Dish Washing Liquid ONO

Packing : 20Ltrs

Code: ABI120



سائل غسيل الاواني - اونو

Dish Washing Liquid ONO

Packing : 200Ltrs

Code: ABI176



منظف الأفران

Oven Cleaner

Packing : 4x5Ltr

Code: ABI155

Code: ABI156



منظف الزجاج

Glass Cleaner

Packing : 675ml/5Ltrs ABI155 / 156

Code: ABI167

Code: ABI190

MOH-APPROVED



منظف قلوي

Alkaline Cleaner

Packing : 4x5 Ltr

Code: ABI178 5Ltr

Code: ABI189 1Ltr

MOH-APPROVED



منظف حمضي

Acidic Cleaner

Packing : 4x5Ltr

Code: ABI181

MOH-APPROVED



منظف أرضيات متعادل

Floor Cleaner Neutral

Packing : 4x5Ltr

Code: ABI182

MOH-APPROVED



ملمع الأرضيات

Floor Polish

Packing : 4x5Ltr

Code: ABI188

MOH-APPROVED



مزيل تلميع الأرضيات

Floor Polish Remover

Packing : 4x5Ltrs

Code: ABI114



MOH-APPROVED



منظف متعادل للأرضيات

Floor Cleaner Neutral

Packing : 1Ltr

Code: ABI150



شامبو السجاد

Carpet Shampoo

Packing : 4x5Ltrs

Code: ABI119



شامبو للسجاد بالرغوة

Carpet Shampoo-Foam

Packing : 4x5Ltrs

Code: ABI149

Code: ABI163



شامبو السيارات

Car Shampoo

Packing : 5/ 200Liters ABI163 / 149

Code: ABI122



شامبو السيارات

Car Shampoo

Packing : 20Liters

Code: ABI137



سائل دريبو ماتيك

Dripo Matic Fluid

Packing : 4x5Ltrs

Code: ABI160



منظف المراض

Toilet Bowl Cleaner

Packing : 4x5 Ltr

Code: ABI157



مزيل الشحوم

Grease Remover

Packing : 4x5 Ltr

Code: ABI183



MOH-APPROVED



منظف الالستانلس استيل

Stainless Steel Cleaner

Packing : 4x5Ltr

Code: AMLC103



مسحوق الصابون

Soap Powder Bag

Packing : 25Kg

Code: AMLC101

Code: AMLC102



Focus Flash



منظف المراض

Toilet Cleaner Focus

Packing : 920ml/1ltrs AMLC102 / 101

Go Green
To Make
Our Planet
Clean

Code: LIKT101



MADE IN TURKEY



معقم للأرضية وبخاخ الأسطح

Disinfectant Floor & Surface Spray

Packing : 400ml

Code: ASCPC145



MADE IN KUWAIT



بودر لتنظيف السيراميك مرمر

Scouring Powder MAR MAR

Packing : 500gm/can

Code: ASI103



MADE IN KUWAIT



قاتل حشرات

Insect Killers

Packing: 12x300ml

Code: AMLC112



MADE IN UAE



مسلك بلاعات - كريستال

Drain Opener - Crystal

Packing : 500gm

Code: AMLC111



MADE IN UAE



مسلك بلاعات - سائل

Drain Opener - Liquid

Packing : 1Ltr

Code: LIKT102 Potpourri

Code: LIKT103 Natural

Code: LIKT104 Lemon



MADE IN TURKEY



ملمع الأثاث

Furniture Polish

Packing : 12x300ml

Code: CLEU101



MADE IN UK



ملمع ومنظف الفولاذ المقاوم للصدأ

Stainless Steel Polish & Cleaner

Packing : 400ml



MADE IN TURKEY



ملمع استانلس استيل

Stainless Steel Polish

Packing : 300ml

Live Green
With The
Best
Cleaning
Solution

Code: ISWS105 Rose
Code: ISWS106 Lavender



أقراص نفتالين بعلاقة

Naphthalene Block Wiese

Packing : 100gm

Code: RPTD103



شاشة مبيولة ضد الطرطشة ضد الطرطشة

Urinal Screen-Anti Splash

Packing : Each

Code: OM123



كرات النفتالين

Naphthalene Balls

Packing : 50grm and 100grm

500ml



معطر جو

Air Freshener

Packing : 500ml

Code: LIKT126 Jasmine
Code: LIKT130 Lavender

Code: LIKT128 Lemon
Code: LIKT127 Orange

Code: LIKT125 Rose



Code: LIKT133 Strawberry

Code: LIKT135 Bakhour

Code: LIKT144 After Rain



300ml



معطر جو

Air Freshener

Packing : 300ml

معطر جو

Air Freshener

Packing : 300ml

Code: LIKT116 Jasmine
Code: LIKT123 Moss & Spring



عبوة جهاز معطر الهواء
Refill For Air Freshener Dispenser
Packing : 250gm

Code: LIKT118 Bosphorus & Beauty
Code: LIKT107 Levender



عبوة جهاز معطر الهواء
Refill For Air Freshener Dispenser
Packing : 250gm

Code: LIKT110 Orange
Code: LIKT121 Chamomille



عبوة جهاز معطر الهواء
Refill For Air Freshener Dispenser
Packing : 250gm

Code: LIKT108 Rose
Code: LIKT115 Musk



عبوة جهاز معطر الهواء
Refill For Air Freshener Dispenser
Packing : 250gm

Code: LIKT109 Lemon
Code: ISWS106 Bakhour



عبوة جهاز معطر الهواء
Refill For Air Freshener Dispenser
Packing : 250gm

Code: EPST101 Musk



عطر سائل لأجهزة التعطير
Perfume For Diffuser Aroma
Packing : 500ml

Code: EPST103 Velve Orchid



عطر سائل لأجهزة التعطير
Perfume For Diffuser Aroma
Packing : 500ml

Code: EPST107 Rosana



عطر سائل لأجهزة التعطير
Perfume For Diffuser Aroma
Packing : 500ml

Code: EPST111 Fiercy



عطر سائل لأجهزة التعطير
Perfume For Diffuser Aroma
Packing : 500ml



معطر جو Diffuser Aroma

جهاز معطر جو أوماتيكي
عطر يغطي مساحة ١٠٠ متر ٢

100m³

Scent
Coverage
Area

RS6500 Diffuser Aroma Scent Coverage Area 100 m³

Code: GATCM109 Black

Code: GATCM110 White



ELECTRICAL
OPERATED

Product Size	:L320xW190xH130mm
Package Size	:L330xW200xH140mm
Power	:8W
Noise Level	:<42dBa
Weight	:1.2kg
Net Weight	:0.6kg
Suitable Coverage	:300CBM / 100 Sqm
Oil Consumption	:1ml/h±5%
Color	:White/black
Voltage	:12V Electricity
Installation	:Wall-Mounted installed.
Bottle Capacity	:100 ML oil Bottle

IMPROVE YOUR TASTE IN LIFE

Create a natural environment with pure scent

Code: SCA102

جهاز معطر جو اتوماتيكي للأماكن الكبيرة

A1-V3.1 Diffuser Aroma

Scent Coverage area 120 m³



Battery powered



Bluetooth APP



Lock



Ultra-fine atomized particles



120 m³

Scent Coverage Area

- Battery powered/USB cable
- Button version/Bluetooth version for choice
- Essential oil diffuser
- 5 working period time programming/
- 10 intensity level



Power: 5W

Coverage: 4,200ft³(120m³)

Bottle Capacity: 100ml

Input voltage: USB 5V

Battery: 0.9~1.5V

Usage: wall mounted, stand alone

Consumption: 0.4ml/h

AE108 Diffuser Aroma

Scent Coverage area 120 m³



120m³
Scent
Coverage
Area



Model Number	: AE108
Product Size	: 174 x 63 x 156 mm
Colors	: White, Black
Refill	: Essential Oil
Bottle Capacity	: 100 ml
Material	: Plastic
Control	: Bluetooth
Voltage	: 5 V (Battery / USB-C)
Power	: 1.5 W
Consumption	: 0.05 - 0.35 g / hr
Coverage	: 30 m ² / 90 m ³ / 3200 ft ³
Technology	: Twin-Fluid Nebulization
Usage	: Wall Mounted
Application	: Hotel Corridor, Restroom, Elevator, Boutique...



Diffuser Aroma | 37 A

IMPROVE YOUR TASTE IN LIFE

Create a natural environment with pure scent

Code: SCA101

جهاز معطر جو اتوماتيكي للأماكن الكبيرة

AE 106 Diffuser Aroma

Scent Coverage area 150 m³



Battery powered



Bluetooth APP



Lock

AE 106

- Battery powered/USB cable
- Bluetooth App Control
- Essential oil diffuser
- Four D-size batteries, long lasting

150 m³

Scent Coverage Area



Model: AE 106

Dimension: 100*77*230mm

Material: Plastic

Color: white

Net weight: 113g

Consumption: 0.05-0.5ml/h

Coverage: 150m³

Bottle Capacity: 500ml

Input voltage: 100-15V

Battery: D-Size 1.5V*4

Power: 1.5W

Design: Safe lock design, Modeling design

Usage: wall mounted, table stand

A501

Bluetooth Version

- Bluetooth app control
- Essential oil diffuser
- 10 intensity level

150m³

Scent Coverage Area



Battery powered



Bluetooth APP



Lock



Ultra-fine atomized particles



APP
BLUETOOTH
CONTROL



BATTERY
POWERED

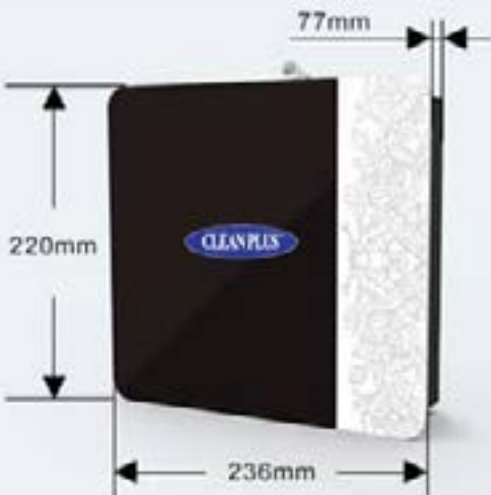

Model: A501

Material: Metal+Acrylic

Dimension: 236*220*77 mm

Weight: 2.35kg/pcs

Inout Voltage: DC12V

Power: Battery D-size 1.5V*3

Coverage: 150m³

Packing: 6 pcs/Ctn

Bottle: 500ml

Usage: wall mounted, stand alone

SE005B Button Version

- Simple and generous design
- Acrylic cover with sucker
- Essential oil diffuser

SE005B Diffuser Aroma

Scent Coverage area 500 m³



Time programming



HVAC connecting



Multi intensity



Ultra-fine atomized particles

INNER
OPERATING
SCREEN



WALL
MOUNTING
DESIGN



500m³

Scent
Coverage
Area



Model: SE005B

Material: Aluminium & Acrylic

Volume: 205*88*205mm

Net Weight: 2.90kg/pcs

Voltage: DC12V

Power: 6W

Coverage: 500m³

Packing: 6pcs/CTN

Bottle: 480ml

Usage: HVAC, stand-alone, wall mounting

SE8150A Diffuser Aroma

Scent Coverage Area 150m³

150m³
Scent
Coverage
Area

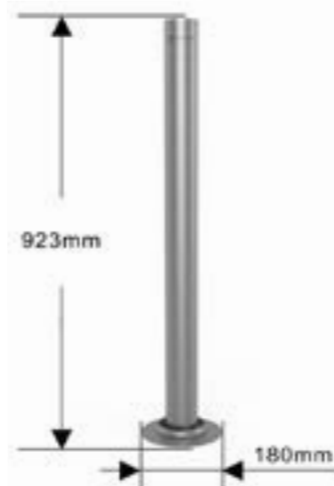

- Model Number : SE8150A
- Brand Name : SCENTA
- Product Size : 180 x 180 x 923 mm
- Colors : Black, Silver, Gold, Titanium
- Material : Aluminium
- Bottle Capacity : 120 ml
- Input Voltage : DC 12V
- Power : 5W
- Consumption : 0.03 - 0.38 g / hr
- Coverage : 50 m² / 150 m³
- Usage : Floor Standing

Diffuser Aroma | 36 C

100m³

Scent
Coverage
Area

Cold air diffusion technology (nebulizing technology) is the technology that diffuses the nano-size fragrance mist to the atmosphere to create scented air.

S80 Diffuser Aroma

Scent Coverage area 100 m³

Code: GATCM107 Black

Code: GATCM108 White



Advantage



Plastic material



Coverage area
100m³



With LCD screen



Silent operation
low noise reduction



Use battery or be
electricity



Bottle capacity
100ml



Product size	: L(170) x W(86) x H(230)mm.
Power	: 1.5W.
Voltage	: DC 5V.
Oil Consumption	: 2.5ml/H±5%.
Noise Level	: 53dBa.
Fragrance oil capacity	: 100ml.
Net Weight	: 1.4kg.

Cold air diffusion technology (nebulizing technology) is the technology that diffuses the Nano-size fragrance mist to the atmosphere to create scented air.

A80 Diffuser Aroma

Scent Coverage area 100 m³

Code: GATCM102



100 m³
Scent Coverage Area

Advantage

 Plastic material	 Coverage area 100m ³
 With LCD screen	 Silent operation low noise reduction
 Use battery or 5v electricity	 Bottle capacity 100ml



Product size	: L(106) x W(93) x H(200)mm.
Power	: 1.5W.
Voltage	: DC 5V.
Oil Consumption	: 0.2ml/min±5%.
Noise Level	: 49 - 50dBa.
Fragrance oil capacity	: 100 ml.
Net Weight	: 0.7 kg.

HVAC scenting

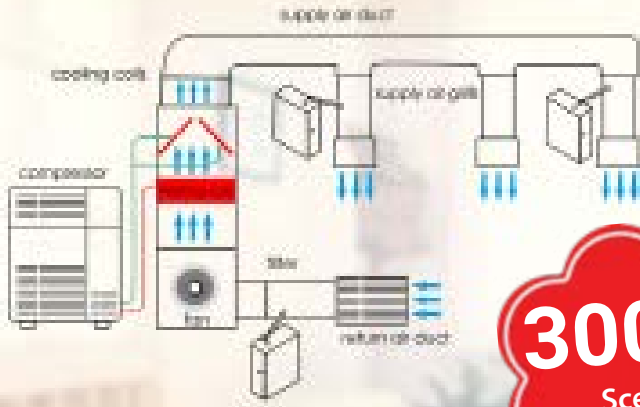

Cold air diffusion technology (nebulizing technology) is the technology that diffuses the Nano-size fragrance mist to the atmosphere to create scented air.

300m³

Scent Coverage Area

Suitable Application:

- Hotel
- Stairway
- Retail shop
- Toilet
- Bathroom

K401 Diffuser Aroma

Scent Coverage area 300 m³

Code: GATCM114

Advantage

ELECTRICAL OPERATED



Metal material



Coverage area 300m³



With LCD screen



Silent operation low noise reduction



Built in fan



Smart APP Available



Product size	: L(180) x W(65) x H(230)mm.
Power	: 4.5W.
Voltage	: DC 12V.
Oil Consumption	: 1ml/min±5%.
Noise Level	: <51dBa.
Fragrance oil capacity	: 150 ml.
Net Weight	: 2.3 kg.

Refills :150 ml
Fragrances: Rosana, Meyzunaf, Jasmine
Fiercy, Bakhour, Orchid, Musk



S1000 Diffuser Aroma

Scent Coverage area 1000 m³

Code: GATCM104 Black

Code: GATCM105 White

Cold air diffusion technology (nebulizing technology) is the technology that diffuse the Nano-size fragrance mist to the atmosphere to create scented air.

1000m³
Scent Coverage Area



Advantage

ELECTRICAL OPERATED

- Metal material
- Coverage area 1000m³
- With LCD screen
- Silent operation low noise reduction
- HiDAC connecting
- Smart APP Available



- Product size : L(290) x W(100) x H(265)mm.
- Power : 12 W.
- Voltage : DC 12V.
- Oil Consumption : 3ml/H
- Noise Level : 54-55dBa.
- Fragrance oil capacity : 500 ml.
- Net Weight : 4 kg.

A316 Diffuser Aroma

Scent Coverage area 900 m³

Model Number : A316
Product Size : 195 x 150 x 585 mm
Material : Stainless Iron + Glass + Plastic
Input Voltage : DC 12 V
Power : 12 W
Bottle Capacity : 1000 ml
Consumption : 0.25 - 5.0 g / hr
Coverage : 900 m² / 2700 m³ / 95310 ft³
Technology : Twin-Fluid Nebulization

900 m³
Scent Coverage Area



Advantages

- Adjustable scent intensity
- Smart timing
- Large capacity
- Extensive coverage
- Whisper quiet
- Elegant Aesthetics
- Smart APP Control
- User-friendly operation



Applicable Places



A304 Diffuser Aroma

Scent Coverage area 800 m³



800 m³
Scent
Coverage
Area

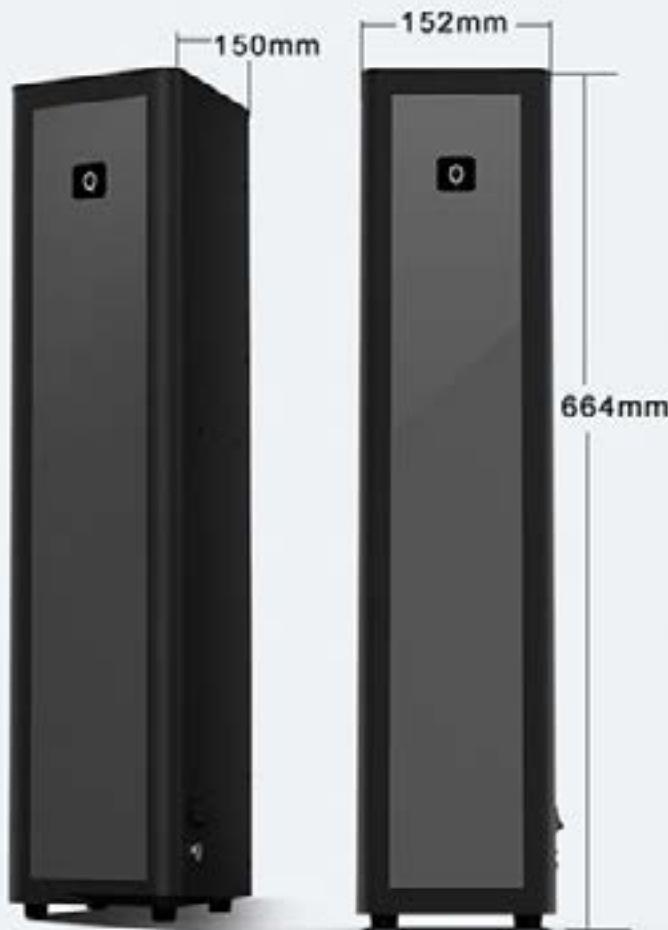

Model:A304

Material:METAL

Color : Black

Net weight: 7.2KG

Coverage: 2500M³

Power: 10w

Bottle capacity: 1000ml

Inputvoltage: DC12V

Consumption: 0.3-3.7ml/hr

Application:Hotel,Lobby,bar

HVAC scenting

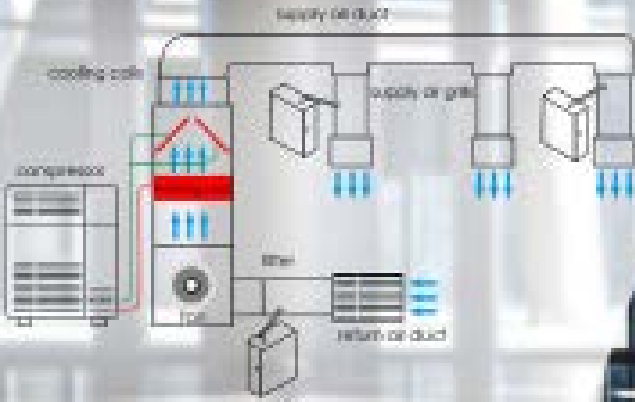

Cold air diffusion technology (nebulizing technology) is the technology that diffuse the Nano-size fragrance mist to the atmosphere to create scented air.

2000m³
Scent Coverage Area

S500 Diffuser Aroma

Scent Coverage area 2000 m³

Code: GATCM101



ELECTRICAL OPERATED



Advantage

- Plastic housing with acrylic customizable front cover
- Coverage area 2000m³
- With LCD screen
- Silent operation low noise reduction
- Built in fan
- Smart App Available



- Product size : L(310) x W(114) x H(218)mm.
- Power : 17 W.
- Voltage : DC 12V.
- Oil Consumption : 4-5ml/H
- Noise Level : 54-55dba.
- Fragrance oil capacity : 500 ml.
- Net Weight : 4 kg.

HVAC scenting

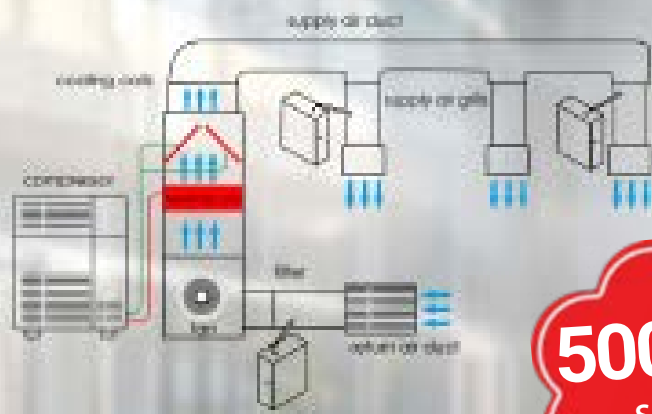

Cold air diffusion technology (nebulizing technology) is the technology that diffuse the Nano-size fragrance mist to the atmosphere to create scented air.

5000m³

Scent Coverage Area

B5000 Diffuser Aroma

Scent Coverage area 5000 m³

Code: GATCM106



Advantage

ELECTRICAL OPERATED



Metal material



Coverage area 5000M³



With LCD screen



Silent operation low noise reduction



Built in fan



Smart APP Available

Smart programme controller:

- 4 Events control
- 24 hours setting system
- Smell concentration control
- Wifi App control optional

Product size	: L(280) x W(130) x H(360)mm.
Power	: 25 W.
Voltage	: AC 220V.
Oil Consumption	: 6-7ml/H ± 5%.
Noise Level	: 53-54dBa.
Fragrance oil capacity	: 1000 mL.
Net Weight	: 7.5 kg.

HVAC scenting

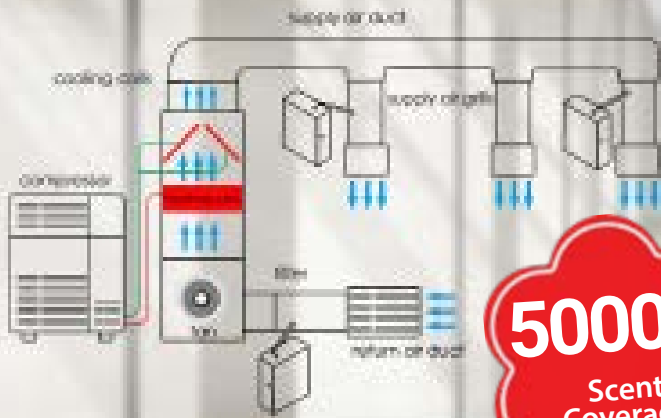

5000m³

Scent Coverage Area

CLEAN PLUS

Cold air diffusion technology (nebulizing technology) is the technology that diffuses the Nano-size fragrance mist to the atmosphere to create scented air.

P5000 Diffuser Aroma

Scent Coverage area 5000 m³

Code: GATCM103



Advantage



ELECTRICAL OPERATED



Metal material



Coverage area 5000m³



With LCD screen



Silent operation (low noise reduction)



2*1000ML Bottle or 2*5L Bottle



Smart APP Available

Smart Programme Controller

4 Events control

24 Hours setting system

Smell Concentration

Wifi App control optional

Product size : L(242) x W(200) x H(161)mm.

Power : 12 x 3 W.

Voltage : DC 12V.

Oil Consumption : 4-5 ml/H ± 5%.

Noise Level : 51-53dBa.

Fragrance oil capacity : 2 x 1000 ml.

Net Weight : 4.6 kg.

A315 Diffuser Aroma

Coverage area
450/ 1500/ 2400 m³



HVAC / Wall-mounted / Stand alone

A315S

Dimension: 180*300*250mm

Evolution: 20ml

Consumption: 0.75-1.5gh

Input Voltage: DC 12V

Power: 25W

Coverage: 450m³/1500m³/2400m³

Material: PC and Glass

Warranty: 1yr

Color: Black

A315M

Dimension: 200*300*310mm

Evolution: 20ml

Consumption: 0.75-1.5gh

Input Voltage: DC 12V

Power: 25W

Coverage: 450m³/1500m³/2400m³

Material: PC and Glass

Warranty: 1yr

Color: Black

A315L

Dimension: 300*300*400mm

Evolution: 20ml

Consumption: 0.75-1.5gh

Input Voltage: DC 12V

Power: 25W

Coverage: 450m³/1500m³/2400m³







Material: PC and Glass

Warranty: 1yr

Color: Black



Model: A315 S/M/L

-  Safe lock design
-  Low noise
-  Bluetooth APP
-  Elegant design
-  built-in fan
-  Time programming
-  Fast 360° aluminum air outlet

Diffuser Aroma | 45A

Diffuser Aroma

Coverage area
5000 m³

JY5000

- Simple and generous design
- Acrylic cover with sucker
- Essential oil diffuser
- 5 working period time programming/20 intensity level



Time programming



Connect to HVAC



Multi Intensity



Ultra-fine atomized particles



Model: JY5000

Material: Aluminum&Metal

Volume: 300*150*360mm

Net Weight: 7.05kg

Input Voltage: 110V/220V

Power: 20W

Coverage: 5000 m³

Usage: HVAC, stand alone

Bottle: 1000ml

Diffuser Aroma

Coverage area
5000 m³

SE5000

- Large oil capacity(5L)
- Essential oil diffuser
- 5 working period time programming/20 intensity level



Time programming



Large coverage



Multi intensity



Ultra-fine atomized particles

TOUCH SCREEN



2.5L*2 LARGE CAPACITY



Model: SE5000

Material: Aluminum

Dimension: 255*153*157mm

Net Weight : 4.2kg

Voltage: DC12V

Power: 25W

Coverage: appr.5000m³ Coverage

Usage: HVAC stand-alone

Bottle: 2.5L*2

Diffuser Aroma | 45C

Diffuser Aroma

Coverage area
2000 m³

SE6400

WIFI Version

- 5 sets time programming for Mon-Sun
- Essential oil diffuser
- 20 intensity level



Time programming



HVAC connecting



Multi-intensity



Ultra-fine atomized particles

WIFI CONTROL



HVAC CONNECTING



Model: SE6400 wifi

Material: Metal

Dimension: 356*295*96mm

Net Weight: 4.4kg/pcs

Voltage: DC12V

Power: 6W

Coverage: 2000 m³

Bottle: 500ml

Consumption: 0.15-3.0ml/hr

Usage: HVAC, stand-alone, wall mounting

CLEANMIST

Diffuser Aroma

Coverage area
150 m³

SE8150D

- Bluetooth app control
- Essential oil diffuser
- 9 intensity level



Touch screen



Multi intensity



Fashion design



Ultra-fine atomized particles

Diffuse your essential oils with ease and elegance with the Nano Mist Electronic Aroma Diffuser. Whisper-quiet yet powerful, this essential oil diffuser preserves the integrity of your essential oils and provides quality scent with style in your living room, bedroom or small office.



Model: SE8150D

Material: Aluminum

Dimension: 112*293 mm

Net Weight: 1.4kg/pcs

Voltage: DC12V

Power: 5W

Coverage: 150 m²

Usage: stand-alone, tabletop

Bottle: 120ml



منتجات ورقية Paper Products

Code: LKT111



رول ورق تواليت طبقتين

Paper Toilet Roll, 2ply **22.5mtr**

Packing: 3x24 rolls

Code: LKT107



رول ورق حمام مني ت. بوكس ١٥٠ متر

Paper Toilet Mini Jumbo Roll, 2Ply, **150mtr**

Packing: 1x12 rolls / Ctn

Code: JMMC104



رول ورق التواليت بدون كور ، طبقتين ، ١٠٠ متر

Paper Toilet Roll Coreless, 2 Ply, **100mtr**

Packing: 1x32 rolls / Ctn

 <p>Size: 24x21.5cm</p> <p>ورق تنشيف الأيدي - Z فولد طبقتين Paper Towel Z Fold, 2ply Packing: 25Pkt x150 sheets</p>		<p>Classic</p>  <p>Size: 21x24cm</p> <p>ورق تنشيف الأيدي - V فولد طبقتين Paper Towel V Fold, 2ply Packing: 20Pkt x200 sheets</p>
---	---	---

Code: LKT103



Size: 23x21cm-36 GSM

ورق تنشيف الأيدي - Z فولد طبقتين
Paper Towel Z Fold, 2ply
Packing: 24Pkt x150 sheets / 20Pkt x200 sheets

Code: LKT102 150 Sheets
Code: LKT109 200 Sheets



Size: 23x21cm-36 GSM

ورق تنشيف الأيدي - V فولد طبقتين
Paper Towel V Fold, 2ply
Packing: 24Pkt x150 sheets / 20Pkt x200 sheets

Code: GPMC104



ورق تنشيف الأيدي - V فولد طبقتين
Paper Towel V Fold, 2ply
Packing: 24Pkt x150 sheets

Code: VCU104



Size: 23.5x24cm-32.54 GSM

ورق تنشيف مالتى فولد - جرين سيل
Paper Towel Multifold Preserve
Packing : 250 sheets /Pk, 1x16 /Case

Code: VCU101



Size: 32.54 GSM

رول ورق تنشيف صديقة البيئة - جرين سيل
Paper Towel Centerpull Preserve
Packing : 1x6rolls

Code: AJFTC110



Size: (W)22cms, 19GSM
Size: (W)20cms, 17GSM

رول ورق كبير لتنشيف الأيدي
Paper Towel Center Pull
Clean Plus - Packing: 1x6rolls

Code: AJFTC109



250mtr



Size: (W)22cms, 19GSM
Size: (W)20cms, 17GSM

رول ورق كبير لتنشيف الأيدي

Paper Towel Center Pull

Clean Plus - Packing: 1x6rolls

150mtr



Size: (W)22cms, 19GSM

رول ورق صغير لتنشيف الأيدي

Paper Towel Mini Center Pull

Clean Plus - Packing: 1x12 rolls

350mtr



Size: (W)21cms, 23GSM

رول ورق كبير لتنشيف الأيدي

Paper Towel Center Pull

Clean Plus - Packing: 1x6 rolls

Code: JMMC102



140mtr



Size: (W)20cms, 45GSM

رول ورق تنشيف اوتوكت طبقتين

Paper Towel Auto Cut Roll, 2 Ply

Packing: 1x6rolls

Code: JMMC101 180mtr



180mtr



Size: (W)21cms, 38GSM

رول ورق تنشيف اوتوكت طبقتين - بدون كور

Paper Towel Roll Autocut Coreless, 2 Ply

Packing: 1x8rolls

CORELESS ROLL TECHNOLOGY



As a coreless Towel roll with high capacity features with Extra wet strength each roll is more longer than our standard roll. As an environmentally friendly Towel roll, it eliminates the cardboard core, paper wrap, space, cost and many other banifits which meets EPA standards, and is FSC and Ecolabel certified.

Code: SKI01



140mtr



Size: (W)20cms

رول ورق تنشيف اوتوكت طبقتين

Paper Towel Auto Cut Roll, 2 Ply

Packing: 1x6rolls

Code: LKT110



125mtr



Size: (W)20cms, 36GSM

رول ورق تنشيف اوتوكت طبقتين

Paper Towel Auto Cut Roll, 2 Ply

Nua - Packing: 1x6rolls

1000mtr



Size: 25cm - 25GSM

رول ورق تنشيف صناعي

Towel Industrial Jumbo Roll - 1Ply

Packing: Each



Code: VCU102

MADE IN KUWAIT

25mtr

16mtr

Size: (W)10cms

ورق تواليت طبقتين
Paper Toilet Roll, 2 Ply
Clean Plus - Packing: 1x100 rolls and 1x96 rolls

MADE IN USA

GREEN SEAL CERTIFIED

45mtr

Size : 2 Ply, 14.97 gsm/ply

رول ورق تواليت - صديقة للبيئة
Paper Toilet Tissue Roll Preserve
Packing: 1x96rolls/case

Code: LKT104

MADE IN TURKEY

علبة محارم بريميموم ، ٣ طبقات ١٠٠ ورقة
Tissue Box Premium - NUA, 3 Ply 100sheets
Nua - Packing: 1x24Box

100Sheets 150Sheets 200Sheets

MADE IN KUWAIT

علبة محارم طبقتين
Tissue Box - CLEANPLUS, 2Ply
Clean Plus - Packing: 1x50 Boxes

MADE IN KUWAIT

ورق سفرة أبيض
Paper Napkin White
Packing: 1x2000 sheets/case

Size: 23x23cm, 33x33cm , 40x40cm

Code: LKT108

MADE IN TURKEY

50mtr

رول مفرش سرير طبي ٥٠ متر
Paper Medical Bed Sheet - 2ply
Packing: 200 sheets/Roll

Size: 18GSM

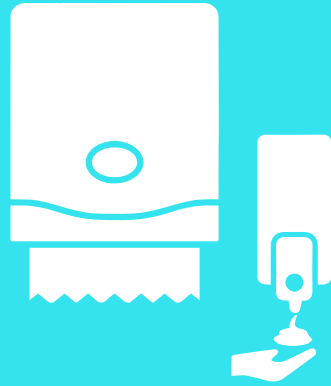

أجهزة Dispensers

Dispenser Towel Autocut - **Sensor** | Dispenser Towel Autocut - **Manual** | Dispenser Towel Center Pull - **Mini & Maxi**

Dispenser Towel C-Z Folded, Sheets - 400,600,700

Toilet Paper Dispenser

Dispenser - Toilet Seat Cover

Dispenser Soap **Sensor** 500ml/1000 ml.

Dispenser Soap **Manual** 500ml/1000ml.

Dispenser Urinal Sanitizer

Portable Table Top **Sensor** Dispenser 500ml/1000ml

Hand Dryer Machine

CleanPlus Family Dispensers

Autocut Hand Towel, Toilet Paper and Soap Dispenser offers various added values out of one hand.

- Lockable and secure
- Modern, beautifully-shaped design
- Novelty with real added values
- Different colour variations can be harmonized optimally
- Detachable wall plate for flexible handling



Suitable for every environment

Whether in schools, wash rooms, restaurants or hotels.

The decor diversity and the high quality finishing of all dispensers of the COSMOS series ensure an universal usability.

Available Colors

- White
- Black
- Black/White
- Black/Silver

Customized designs
and more color options
available upon request



Code: JMMD104



MANUEL



جهاز رول ورق تنشيف اوتوكت

Dispenser Paper Towel Autocut

Size: (W x H x D): 320 x 430 x 210mm

Code: JMMD103



MANUEL



جهاز رول ورق تنشيف اوتوكت

Dispenser Paper Towel Autocut

Size: (W x H x D): 320 x 430 x 210mm

Code: JMMD102



MANUEL



جهاز رول ورق تنشيف اوتوكت

Dispenser Paper Towel Autocut

Size: (W x H x D): 320 x 430 x 210mm

Code: JMMD116



SENSOR



4 x D 1.5 V Batteries

جهاز رول ورق تنشيف اوتوكت - سنسر

Dispenser Paper Towel Autocut

Size: (W x H x D): 320 x 430 x 210mm

Code: JMMD114



SENSOR



4 x D 1.5 V Batteries

جهاز رول ورق تنشيف اوتوكت - سنسر

Dispenser Paper Towel Autocut

Size: (W x H x D): 320 x 430 x 210mm

Code: JMMD115



SENSOR



4 x D 1.5 V Batteries

جهاز رول ورق تنشيف اوتوكت - سنسر

Dispenser Paper Towel Autocut

Size: (W x H x D): 320 x 430 x 210mm

CORELESS TOWEL DISPENSER TECHNOLOGY

Code: GFAPD104



Super Compact Sensor Paper Towel Dispenser

- Super compact design for regular roll
- Working with 6pcs C size alkaline batteries (LR14) or 6V DC power supply
- Touch free, wave your hand to dispense towel sheets
- LED warning when towel is low
- Sheet length can be adjustable
- Recyclable polypropylene material, Eco-friendly
- Security key and lock
- Color options: translucent white, black and customized colors



جهاز رول ورق تنشيف اوتوكت - سنسر
Dispenser Paper Towel Autocut Compact
Size: 295 x 210 x 304mm

Code: JMMD113



Twin Roll



حامل رول ورق تواليت

Dispenser Paper Toilet Tissue

Size: (W x H x D): 155 x 325 x 175mm

Code: JMMD111



Twin Roll



حامل رول ورق تواليت

Dispenser Paper Toilet Tissue

Size: (W x H x D): 155 x 325 x 175mm

Code: JMMD112



Twin Roll



حامل رول ورق تواليت

Dispenser Paper Toilet Tissue

Size: (W x H x D): 155 x 325 x 175mm

Code: JMMD110



MANUEL
1000ml



موزع صابون فوم

Dispenser Soap Foam

Size: (W x H x D): 105 x 240 x 120mm

Code: JMMD108



MANUEL
1000ml



موزع صابون فوم

Dispenser Soap Foam

Size: (W x H x D): 105 x 240 x 120mm

Code: JMMD109



MANUEL
1000ml



موزع صابون فوم

Dispenser Soap Foam

Size: (W x H x D): 105 x 240 x 120mm

Code: JMMD107



SENSOR
1000ml



موزع صابون فوم

Dispenser Soap Foam

Size: (W x H x D): 105 x 250 x 120mm

Code: JMMD106



SENSOR
1000ml



موزع صابون فوم

Dispenser Soap Foam

Size: (W x H x D): 105 x 250 x 120mm

Code: JMMD105



SENSOR
1000ml



موزع صابون فوم

Dispenser Soap Foam

Size: (W x H x D): 105 x 250 x 120mm

Code: LOSS107



MANUEL
1000ml



حامل صابون يدوي
Dispenser Soap
Size: 210 x 112 x 105mm

Code: LOSS127



MANUEL
1000ml



حامل صابون يدوي
Dispenser Soap
Size: 210 x 112 x 105mm

Code: LOSS114



MANUEL
1000ml



حامل صابون يدوي
Dispenser Soap
Size: 225 x 112 x 90 mm

Code: LOSS115



MANUEL
1000ml



حامل صابون يدوي
Dispenser Soap
Size: 225 x 112 x 90 mm

Code: LOSS103



600 Sheets



حامل ورق تنشيف V ، C ، Z - فولد
Dispenser Paper C, V, Z -Fold
Size: 271 x 360 X 131mm

Code: LOSS104



600 Sheets



حامل ورق تنشيف V ، C ، Z - فولد
Dispenser Paper C, V, Z -Fold
Size: 271 x 360 X 131mm

Code: LOSS101



حامل رول تواليت ميني تي بوكس
Dispenser Toilet Tissue Mini T.box
Size: 332 x 325 x 120mm

Code: LOSS102



حامل رول تواليت ميني تي بوكس
Dispenser Toilet Tissue Mini T.box
Size: 332 x 325 x 120mm

Code: LOSS124



حامل رول تواليت ميني تي بوكس
Dispenser Toilet Tissue Mini T.box
Size: 290 x 268 x 130mm

Code: LOSS128



MANUEL



جهاز رول ورق تنشيف للأيدي أوتوكوت
Dispenser Paper Towel Autocut

Size: 378 x 280 x 229 mm

Code: LOSS105



حامل رول ورق تنشيف الأيدي
Dispenser Paper Towel Centerpull

Size: 220 x 310 x 220mm

Code: LOSS106



حامل رول ورق تنشيف الأيدي
Dispenser Paper Towel Centerpull

Size: 220 x 310 x 220mm

Code: LOSS111



حامل رول ورق تنشيف الأيدي
Dispenser Paper Towel Centerpull

Size: 365 x 255 x 240mm

Code: LOSS121



حامل رول ورق تنشيف الأيدي
Dispenser Paper Towel Centerpull

Size: 365 x 255 x 240mm

Code: FHTD108



جهاز رول تواليت استانليس استيل
Toilet Tissue Holder - St/Steel

Size: W125 x H90 x D100mm

Code: OPTD120

Code: OPTD118

Code: OPTD119

Code: OPTD121



حامل رول تواليت ميني تي بوكس

v

Size: 260 x 240 x 130mm

Code: OPTD103

400 Sheets



حامل ورق تنشيف V ، C ، Z فولد
Dispenser Paper C, V, Z-Fold

Size: 420 x 250.5 x 90mm

Code: OPTD107

300 Sheets



حامل ورق تنشيف V ، C ، Z فولد
Dispenser Paper C, V, Z-Fold

Size: 240 x 120 x 250.5mm

Code: OPTD102

200 Sheets



حامل ورق تنشيف V ، C ، Z فولد
Dispenser Paper V, C, Z-Fold

Size: 240 x 90 x 250.5mm

Code: OPTD112



حامل ورق لقاعدة الحمام
Dispenser Toilet Seat Paper

Size: 420.5 x 280.5mm

Code: OPTD104

600 Sheets



حامل ورق تنشيف V ، C ، Z فولد
Dispenser Paper C, V, Z-Fold

Size: 420 x 250.5 x 120.5mm

Code: GFAPD102



حامل رول ورق أم
Dispenser Paper Towel Centerpull

Size: L235 x W216 x H366mm

Code: OPTD125



Code: OPTD124



Code: OPTD122



Code: OPTD123



حامل رول ورق

Dispenser Paper Towel Centerpull

Size: 365 x 255 x 240mm

Code: OPTD111



Code: OPTD110



Code: OPTD113



Code: OPTD109



حامل رول ورق

Dispenser Paper Towel Centerpull - Mini

Size: 310 x 220 x 210 mm

Code: OPTD115



Code: OPTD117



Code: OPTD116



500ml

حامل صابون يدوي

Dispenser Soap Manual

Size: 170 x 100.5 x 130.5mm

Code: GFAPD106



MANUEL
750ml



جهاز صابون يدوي
Dispenser Soap

Size: L108 X W103 X H222mm

Code: GFAPD111



MANUEL
1400ml

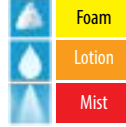

جهاز صابون يدوي
Dispenser Soap

Size: L123xW125xH222mm

Code: GFAPD107



SENSOR
500ml

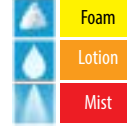

جهاز صابون سنسر
Dispenser Soap

Size: L103 x W103 x H222mm

Code: GFAPD110



SENSOR
1000ml

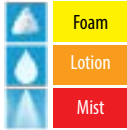

جهاز صابون سنسر
Dispenser Soap

Size: 123 x 120 x 260mm

Code: FHTD106



1200ml



حامل صابون استانلس استيل أفقي
Dispenser Soap Stainless Steel

Type: Horizontal

Code: FHTD107



1200ml



حامل صابون استانلس استيل رأسي
Dispenser Soap Stainless Steel

Type: Vertical

Code: GFAPD113

SENSOR
500ml



لوح وحامل معقم أيدي
Dispenser with Portable Stand - Sensor

Packing: Complete Set

Code: GFAPD114



SENSOR
1000ml



SENSOR
1000ml

لوح وحامل معقم أيدي
Dispenser with Portable Stand

Packing: Complete Set



Code: GFAPD115 500ml

Code: GFAPD116 1000ml



SENSOR

500ml

1000ml



جهاز صابون / معقم أيدي (سنسر)

Dispenser Sensor Sanitizer with Stand – Stainless Steel

Packing: Complete Set

Code: GFAPD109



Refill: 250ml

جهاز معطر جو

Dispenser Air Freshener - Aerosol

Size: L104 x W83 x H220mm

Code: JOFS101



Refill box with 25 plastic bags

حامل أكياس فوط صحية

Dispenser Sanitary Napkin

Size: L130 x W88 x H12mm

0885500011024



حامل صابون قطع - استيل

Soap Basket - Chrome

Packing: Each

Code: FHTD102



500ml
Manual

مضخة صابون

Dispenser Soap for Basin

Spout length: 4inch

Code: JOFSC102



Refill box with 25 plastic bags

حامل أكياس فوط صحية - لون ابيض

Sanitary Napkin Refill

Packing: Each

Our Dispensers
The Key To Your
Hygiene Dreams!

Foam soap dispenser with pouch



Luxury foam soap



Anti Bacterial foam soap



Gardenia foam soap



Rose foam soap



Lemon foam soap



Lavender foam soap



Code: GWTCDD114

SENSOR

1000ml



صابون موزع

Dispenser Soap

Packing: Each

Code: JMMD108



MADE IN GERMANY

MANUEL

SENSOR

1000ml



موزع صابون فوم

Dispenser Soap Foam

Packing: Each

Code: GFAPD110



MADE IN CHINA

SENSOR

1000ml

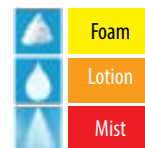

جهاز صابون سنسر

Dispenser Soap

Packing: Each

FULL FAMILY DECOR DISPENSER

Air Freshener



Towel Dispenser



Urinal Dispenser

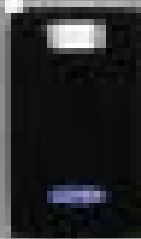

Foot Flap Dispenser



Soap Dispenser



Toilet Brush



Trash Bin



عائلة كاملة اجهزة مرخرفة

جهاز معطر جو

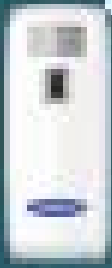

حامل ورق تنظيف ايدي



جهاز تعقيم

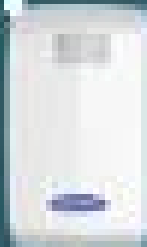

حامل رول توالت بيت



جهاز الصابون



شرشاش حمام



سلة مهملات

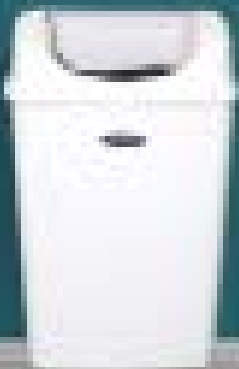



Code: GWTCD104



منشفة ورقية موزع سحب مركزي

Dispenser Paper Towel Centerpull

Size: 225x263x215mm

Code: GWTCD108



موزع مناديل تواليت ميني تي بوكس

Dispenser Toilet Tissue Mini T.box

Size: 284x286x127mm

Code: GWTCD110



Automatic



Refill Capacity: 600ml/6000 doses

جهاز التقتير والتعقيم - ديجتال

Dispenser Urinal Sanitizer

Size: L140 x W80 x H226mm

Code: GWTCD114

SENSOR

1000ml



Foam

Lotion

Mist

صابون موزع

Dispenser Soap

Packing: Each

Code: GWTCD118

MANUAL

500/1000ml



Code: GWTCD112

Automatic



Refill Capacity: 270ml

جهاز معطر جو

Dispenser - Aerosol

Packing: Each

Code: GWTCD102

400Sheets



موزع ورق C، V، Z - أضعاف

Dispenser Paper C, V, Z-Fold

Size 400S: 282x249x100mm







Code: GWTCD120.7



MANUAL

MADE IN CHINA



حامل رول ورق أوتوكوت

Dispenser Paper Towel Autocut

Size: 290 x 363 x 220mm

Code: GWTCD 123.7



MADE IN CHINA



حامل رول تواليت ميني تي بوكس

Dispenser Toilet Tissue Mini T.box

Size: 284x286x127mm

Code: GWTCD 125.7



MADE IN CHINA

Automatic



Refill Capacity: 600ml/6000 doses

جهاز التقطير والتعقيم - ديجتال

Dispenser Urinal Sanitizer

Size: L140 x W80 x H226mm

Code: GWTCD121.7

SENSOR

1000ml

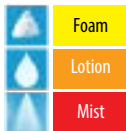

Foam

Lotion

Mist

حامل صابون أيدي

Dispenser Soap

Packing: Each

Code: GWTCD 122.7

MANUAL

1000ml



حامل صابون أيدي

Dispenser Soap

Packing: Each

Code: GWTCD 124.7

Automatic



Refill Capacity: 270ml

جهاز معطر جو

Dispenser - Aerosol

Packing: Each



MADE IN CHINA

Code: RPTT102



MADE IN TURKEY

25/50Ltrs



سلة المهملات مثبتة على الحائط

Trash Bin Wall Mounted

Size 50L: 600x390.5x250.5 mm









Code: M14A



Hand Dryer

مجفف أيدي

Specifications	M14A	المواصفات
Motor Output	420 -1100W	قوة المحرك
Total Power	420 -1500W	إجمالي الطاقة
Frequency	50/60Hz	تكرار
RPM	19000 - 30000	دورة في الدقيقة
Power Source	220 - 240V	مصدر الطاقة
Effective airflow	94 -165m ³ /h	تدفق الهواء الفعال
Air temperature	40°C	درجة حرارة الهواء
Protection rating	IPX4	تصنيف الحماية

Dimension: 665x320x228 mm.

Jet Hand Dryer White Vertical

Code: M88APlus



Hand Dryer

مجفف أيدي

Specifications	M88APLUS	المواصفات
Motor Output	140W	قوة المحرك
Total Power	1640W	إجمالي الطاقة
Frequency	50/60Hz	تكرار
RPM	2800	دورة في الدقيقة
Power Source	220V,240V	مصدر الطاقة
Effective airflow	215 m ³ /h	تدفق الهواء الفعال
Air temperature	57°C	درجة حرارة الهواء
Protection rating	IP23	تصنيف الحماية

Dimension: 303x253x150mm.

Code: M23AWhite



Hand Dryer

مجفف أيدي

Specifications	M23A White	المواصفات
Motor Output	420 -1100W	قوة المحرك
Total Power	420 -1500W	إجمالي الطاقة
Frequency	50/60Hz	تكرار
RPM	19000-30000	دورة في الدقيقة
Power Source	220V,240V	مصدر الطاقة
Effective airflow	252-350 Km/h	تدفق الهواء الفعال
Air temperature	40°C	درجة حرارة الهواء
Protection rating	IP23	تصنيف الحماية

Dimension: 557x344x202mm.

Hair & Body Dryer

Fully Automatic
Dryer for Hair & Body

مجفف للشعر والجسم

Code: OM134

All New HTM DRYERS

Convenience and comfortable
bathroom partner

With Plasma function, you can dry hair & body without any damage, it removes odor and moisture in the bathroom along with purifying the air.

User friendly design with remote control and touch sensor with auto timer function for Hot and Cold air, ideal for any season.



- Voltage : 220 / 50-60Hz
- Material : Flame-retardant ABS
- Specification : 190(W) 280(H) 190(D)
- Maximum power consumption: Hot air (1,000W), cold air (70W)
- Sensor type : Wired touch sensor type / Remote control
- Weight : 2.3KG
- Safety device : Double safety device
(power failure in case of thermal fuse, motor trouble) detection function
- Motor : BLDC
- Velocity : 30m/s
- Noise : 30db or less
- Drying time : 13 seconds(variable)
- Exterior decoration : Grey high-gloss UV color coating
- Plasma : 2011(o) 2013(x)

GENERAL PURPOSE DILUTION SYSTEM

جهاز لخلط مواد التنظيف

Code: ADSTM101

- ✓ % 0.5 - % 16 dosing adjustment with coloured dosage types.
- ✓ Special design combined system which can be connected together.
- ✓ Can be used in various areas (hotel, factory, restaurant, hospital, agriculture sector and etc)
- ✓ Mounting materials, absorption and discharge hose.

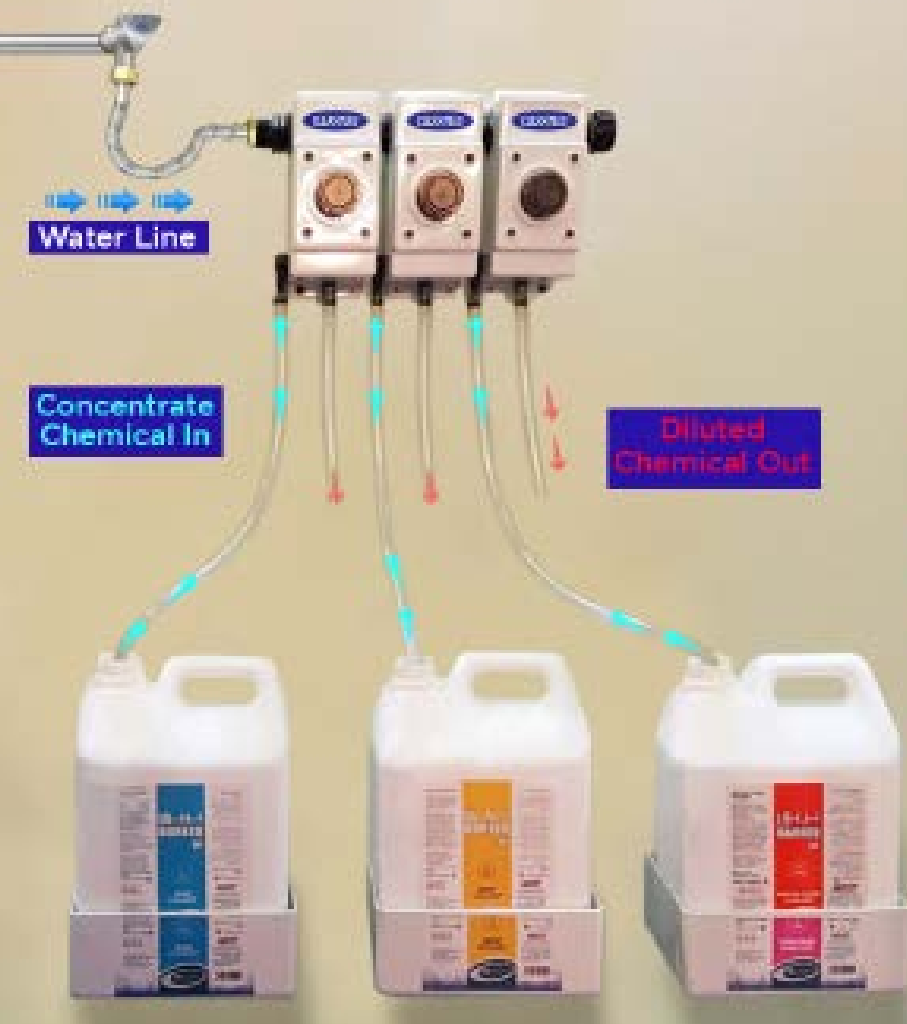



simple green GENERAL PURPOSE DILUTION SYSTEM

- ✓ Ensure proper mixing for specific applications.
- ✓ Special design combined system which can be connected together.
- ✓ Can be used in various areas (hotel, factory, restaurant, hospital, agriculture sector and etc).
- ✓ Mounting materials, absorption and discharge hose.

 **Made in USA**

Code: STC103

جهاز تنظيم خلط المواد Dosing System Detergent and Rinse Pump with RPM Adjustment

Code: ADSTM102





مستهلكات التجهيزات Catering Consumables

Code: M-TGM101,L-TGM102 Powdered
Code: L-TGM101,X-TGM102 Powdered Free



كفوف مطاط عدة مقاسات
Disposable Latex Gloves Powdered / Powder free
Size: XLarge/Large/Medium/Small

Packing: 1x100pcs/pack

Code: M-TGM106,L-TGM105 Powdered Free



كفوف نيتريل عدة مقاسات
Disposable Nitrile Gloves Powder free
Size: Large/Medium

Packing: 1x100pcs / pack

Code: XYI - M, S, L, XL Powdered Free
Code: XYI - M, S, L, XL Powdered



كفوف فينيل عدة مقاسات
Disposable Vinyl Gloves Powdered / Powder free
Size: XLarge/Large/Medium/Small

Packing: 1x100pcs / pack

Code: XYI111



كفوف بلاستيك شفافة
Disposable Plastic Gloves

Packing: 1x100pcs / pack

Code: XYI112



كمام ورق للوجة 2 طبقة
FACE MASK PAPER - 2PLY

Packing: 1x100pcs / pack

Code: XYI113



كمام طبي للوجة 3 طبقة
Face Mask Surgical - 3ply Green

Packing: 1x50pcs/pack

Code: XYI114



كمامات
Dust Mask Round

Packing: 1x50 pcs / pack

Code: OM203



الومنيوم فويل
Aluminium Foil
Size: 40cm x 20cm

Packing: Each

Code: NMCS113 300mtr



رول تغليف شفاف كلينج فيلم
Cling Film - 45CM
Length: 300mtr

Packing: Each

Code: AAPC147 250mtr



بلاستيك مطاط تغليف
Stretch Film - 50cm
Length - 250mtr

Packing: Each

Code: XYI119 Blue

Code: XYI120 White



واقي اليدين للمطبخ
Poly Over sleeves
Size: 40cm x 20cm

Packing: 1x100pcs / pack

Code: XYI118



مريول شيف نايلون
Poly Apron
Size: 28cm x 46cm

Packing: 1x100pcs / pack

Code: XYI115



غطاء راس للمطبخ
Mob Cap
Size: 18"

Packing: 1x100pcs / pack

Code: XYI106



غطاء حذاء بلاستيك
Disposable Plastic Shoe Cover
Size: 15cm x 38cm

Packing: 20 Pkts x 100 Pcs

Code: NMCS131 Paper Cup

Code: NMCS116 Foam Cup



اكواب فوم / بلاستيك عده مقاسات
Disposable Foam / Plastic Cups & Lids
6oz, 7oz & 8oz

Packing: 1x1000pcs / pack



ملاعق وشوك وسكاكين بلاستيك
Plastic Fork, Spoon & Knife

Packing: 1x50pcs/pack



أدوات التنظيف Cleaning Tools



ماكينة تنظيف الواجهات والزجاج العالي Window Cleaning RO System

Code: BYT111

- Rotary Pump 220v -65hz
- Pressure 4-12 bars
- Light Weight
- Pure water production rate 13 ltr/mnt
- Works without electric power with 4 bars water pressure up to 30 m high
- Three types of Brushes
- Angle Adaptor
- TDS Meter
- Optional Dosing Chemical Pump.
- Pole Length : 14mt / 21mt

- مضخة دوارة ٢٢٠ فولت ٦٥ هرتز
- الضغط ٤-١٢ قطب
- خفيفة الوزن
- نسبة إنتاج المياه النقية ١٣ لتر لكل دقيقة
- تعمل بدون طاقة كهربائية مع ضغط مياه يحتوي على ٤ أقطاب إرتفاع حتى ٣٠ م
- ثلاثة أنواع من الفرشاة مهياً زاوية
- ميزان TDS
- مضخة كيميائية ذات جرعة إختيارية



Code: RI-30,40,60



فرشاة خشن بالعصا
Hard Brush with Wooden Handle

Size: 30cm, 40cm & 60cm

Code: VSI101



فرشاة ناعمة بالعصا
Soft Brush with handle

Size: 30cm

Code: VSI109



مكنسة مع جاروف بيد طويلة
Dust Pan Plastic
Long handle with brush

Packing: Each

Code: GBCTE139



مكنسة مع جاروف بغطاء
Dust Pan Plastic Long Handle
with Cover & Brush

Packing: Each

Code: UPTT106



مكنسة مع جاروف بيد طويلة

Dust Pan Plastic with Long Handle Brush Lux

Code: UPTT107



مكنسة مع جاروف بيد طويلة

Dust Pan Plastic with Long Handle Brush Karizma

Code: NZFTB



فرشاة ناعمة مع العصا
Soft Brush with Handle

Packing: Each

Code: UPTT101



فرشاة ناعمة مع العصا
Soft Brush with Handle

Packing: Each

Code: UPTT104



فرشاة ناعمة مع العصا
Soft Brush with Handle

Packing: Each

Code: VSI102



فرشة ناعمة يدوية
Soft Hand Brush

Packing: Each

Code: UPTT102



فرشاة بيد للدعك عدة ألوان
Scrubbing brush jet

Packing: Each

Code: VSI111



فرشاة بيد للدعك عدة ألوان
Scrubbing brush jet

Packing: Each

Code: VSI107



مكنسة صغيرة مع جاروف بلاستيك عدة ألوان
Dust Pan Plastic with Brush Assorted colors

Packing: Each

Code: NNHCT104



جاروف حديد عدة ألوان
Dust Pan Metal - Assorted colors

Packing: Each

Code: NNHCT101



عصا لألتقاط الأغراض
Leaves Picker 83 cm

Packing: Each

Code: RDSITE111



ممسحة تعقيم غرف العمليات
Triggy Applicator
with Replacement Cover

Packing: Each

Code: NNHCT103



ممسحة تنظيف وتعقيم
Wax Applicator

Packing: Each

Code: FWIC102



فرشاة تنظيف للأماكن العالية
High Duster

Packing: Each

Code: SJPC105



علاقة ادوات تنظيف
Tool Holder

Packing: Each

Code: EMC140R/G/B



عصا الومنيوم
Handles - Aluminium

Size: 140cms

Code: SYTC101 Thread

Code: SYTC102



عصا خشب
Handles - Wooden

Size: 120cm

Code: MCST103 125cm

Code: MCST107 140cm

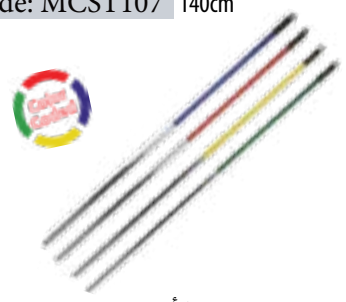

عصا أومنيوم
Alluminium Handle thread & drill hole

Sizes: 125cm & 140cm

Code: GBCTE121-125



عصا تليسكوب عدة أطوال

Telescopic poles 1.8, 3, 4, 4.5 & 9 mtrs

Code: UPTT123-119



فريم ممسحة ميكرو فايبر عدة مقاسات
Damp Mop Frame

Size : 40 & 60cms

Code: RDSITE125-127



فريم مكنسة عدة مقاسات
Dust Control Frame - Size : 40, 60, 80cms

Packing: Each

Code: EMCMH



كليس موب بلاستيك
Mop Holder Plastic
Colors - Blue/Red/Green/Yellow

Packing: Each

Code: MCST111



كليس موب بلاستيك
Mop Holder Plastic
Colors - Blue/Red/Green/Yellow

Packing: Each

Code: CTP135



فوط شراشيب موب دائرية
Round Mop

Packing: Each

Code: CHT110-112



فوط شراشيب قطنية مع كليس بلاستيك
Mop Head Cotton with Plastic Holder
160grm, 200grm & 260grm

Packing: Each

Code: CTP108



فوط شراشيب قطنية مع كليس بلاستيك
Mop Head Premium Cotton 400gsm

Packing: Each

Code: CTP107



غيار فوط شراشيب قطنية
Mop Head cotton 450gsm with color bands

Packing: 2pcs/pkt



Antibacterial Certified



ممسحة مبللة من الألياف الدقيقة مضادة للبكتيريا
AntiBacterial Microfiber Wet Mop - 150gm

Packing : Each



Antibacterial Certified



ممسحة كنتاكي المصنوعة من الألياف الدقيقة المضادة للبكتيريا
AntiBacterial Microfiber Kentucky Mop - 200gram

Packing : Each



Antibacterial Certified



ممسحة مايكروفايبر مضادة للبكتيريا - 40x15 سم
AntiBacterial Microfiber Mop - 15x40cm

Packing : Each



قطعة قماش للأطباق من الألياف الدقيقة - 50 x 50 سم
Microfiber Dish Cloth- 50x50cm

Packing : 2Pcs/Pack



ممسحة مايكروفايبر متعددة الأغراض
Microfiber Multi-Purpose wiper - 30x38cm

Packing : 3Pcs/Pack



قماش مايكروفايبر - 36x38 سم
Microfiber Cloth - 36x38cm

Packing : 4Pcs/Pack



قماش برو مايكروفايبر - 38x36 سم
Pro Microfiber Cloth - 36x38cm

Packing : 6Pcs/Pack

Code: MCSC118



ممسحة شرشيب ميكرو فايبر مدورة ملونة
Microfiber Wet Mop – 150 gram

Packing: Each

Code: MCSC113



ممسحة شرشيب ماكرو فايبر ملونة
Microfiber Kentucky Mop - 200gram

Packing: Each

Code: RDSIC101



فوط ميكرو فايبر للتنظيف عدة مقاسات
Micro Fiber Dust Control Cover - Italy

Size : 40 & 60cms

Code: RDSIC110 Cotton

Code: RDSIC111 Acrylic



غبار مكنسة قطنية
اكريلك للتنظيف عدة مقاسات
Dust Control Cover Cotton & Acrylic

Size: 40, 60, 80cm

Code: CTP108



فوط شرشيب قطنية مع كلبس بلاستيك
Mop Head Premium Cotton 400gsm

Packing: Each

Code: UTPC101-110



فوط ميكرو فايبر للتنظيف عدة مقاسات
Micro Fiber Dust Control Cover - Turkey

Size : 40 & 60cms

Code: VVG101

Electrostatic
charged mop



فورشاغا رول
Forshaga Mop Roll

Size: 20x62 cm, Packing: 100 Mops per Roll

Code: UPTT152

Electrostatic
charged mop
Frame



فورشاغا فريم
Forshaga Mop Frame - 40cm

Packing: Each

Code: GBCTE112-113



ممسحة قطن للزجاج
Window Washer - Size : 35, 45cms

Packing: Each

Code: CHT113-117

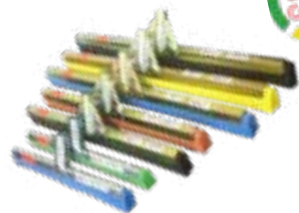

مماسح ربر حديد مع العصا عدة احجام
Rubber squeeze - Metal
Size 35,45,55 & 75cms

Packing: Each

Code: CHT118-120



مماسح ربر بلاستيك مع العصا عدة احجام
Rubber squeeze -Plastic
Size 35,45 & 55cms

Packing: Each

Code: RDSITE116 -118



ممسحة للزجاج بلاستيك
Window Squeeze Plastic
Size: 25, 35 & 45cms

Packing: Each

Code: GBCTE129-132



ممسحة استنلس استيل للزجاج
Window Squeeze - Stainless Steel
Size: 25, 35, 45cms

Packing: Each

Code: GBCTE156



ممسحة للزجاج بيد ثابتة
Window Squeeze Plastic - Fixed handle
Size: 25cm

Packing: Each

Premium Quality Disposable Toilet Brush



ذات استعمال مرة
واحدة بجودة عالية



فرشاة تواليت بلاستيك / استانلس استيل
Toilet Brush Stainless Steel / Plastic

With Disposable Sponge Head

Preloaded with *germ-killing* detergent

Kills **99.99%** of Germs

3 in 1

Refill Holder + Stick + 8 Refills



Powerfully and effectively cleans

Kills
99.9% of
viruses &
bacteria*

*On hard,
non-porous
surfaces.
Use as directed.

Code: NZFTB120 China

Code: UPTT103 Turkey



فرشاة حمام مع قاعدة بلاستيك
Toilet Brush with Holder - Turkey

Packing: Each

Code: VSI108



فرشاة حمام مع قاعدة بلاستيك
Toilet Brush with Holder - Italy

Packing: Each

Code: DMTTE101



فرشاة حمام مع قاعدة استانلس استيل
Toilet Brush with Holder - Stainless Steel

Packing: Each

Code: OM1124



فرشاة حديد
Brush Iron Wire

Packing: Each

Code: OM228 Garden Rake

Code: OM151 Fork Red



شوكة معدنية للحدائق
Garden Rake Zigzag/Fan Type

Packing: Each

Code: OM260-263



مشحاف استيل عدة مقاسات
Floor Scraper
Size: 2,3,4 & 5 inches

Packing: Each

Code: CHT102



مشحاف بشفرات للزجاج بيد
Scrapers with Metal/Plastic Handle
Scrapers Blades

Packing: Each

Code: FWIC104



شفاط للحمام مع عصا خشب
Plunger with Wooden handle

Packing: Each

Code: ZXPTTE102



علامات ارشادية
Floor Sign Board

59.7x29.5x22.5cm (LxWxT)(when it's closed)
40.5x56cm (LxW)(when it's opened)

Packing: Each

Code: AMLCO107



لباد قطع
Scouring Pad Green

Packing: 1x12 pcs

Code: AMLCO101



لباد قطع
Scouring Pad Heavy Duty

Packing: 1x10 pcs

Code: OM139 Steel Ring

Code: OM232 Wool



سيم مدور و ناعم
Steel Ring & Wool

Packing: Big - 1x10 pcs / Small - 1x12 pcs

Code: AMLCO108



اسفنجة تنظيف لجميع الأغراض، صغيرة
All Purpose Cleaning Sponge Small

Packing: 1x10 pcs

Code: AMLCO109



اسفنجة تنظيف لجميع الأغراض كبيرة
All Purpose Cleaning Sponge Big

Packing: 1x9 pcs

Code: AMLCO110



اسفنجة تنظيف لجميع الأغراض كبيرة
All Purpose Cleaning Sponge Big

Packing: 1x12 pcs

Code: AMU103-114



لباد لتنظيف وتلميع الأرضيات
Scrubbing Pad

Black pad - To clean deeply hard floors

Green pad - For resilient floors

White pad - To clean marble or granite

Red pad - For spray cleaning & metallized wax

Size 13" / 17" / 20"

Code: AMFPP



أكياس قمامة عدة قياسات وعدة ألوان
Plastic Garbage Bag
Size / colors

Packing: 10Kg / per packet

Code: AMFPP



أكياس قمامة عدة قياسات وعدة ألوان
Plastic Garbage Bag
Size / colors

Packing: 10Kg / per packet

Code: AMFPP103-109



Any Color – Any Size – Any Micron
أكياس قمامة ملونة – مقاسات مختلفة
Bio-Degradable Plastic Garbage Bag With Tie Rope

Packing: 10Kg / per packet

Code: SSC102

Code: OM312



كفوف عمال / قطن – جلد
Working & Cotton Gloves

Packing: Each

Code: JHCRMP101-114



كفوف ربر عدة قياسات
Rubber Hand Gloves

Packing: Pair

Code: GHNW101



فوط ذات الاستعمال الواحد
Non-woven Cleaning wipes
45gsm - mesh, wave pattern 1/4 Holved
Colors : Blue, Green, Red, Yellow & White

Packing: 1x50 pcs /Pack , Size53x34cm

Code: MCSC102-105



فوطة ميكرو فايبر
Micro Fibre Cloth - Premium

Packing: Each, Size: 38x40cm

Code: CTP119



فوط صفراء
Yellow Duster

Packing: 1x12 pcs per pack

Code: CTP123-124



فوط تنظيف
Kitchen Cloth

Packing: 1x6 & 1x12 pcs /pack, Size: 45x65cm

Code: CTP111-112



فوط أرضية
Floor Cloth
130 grams, 150grams

Packing: 1x3, 1x12 pcs/pkt, Size: 50x60cm

Code: CTP120-121



فوط تنظيف الزجاج
Glass Wiping Cloth

Packing: 1x6 & 1x12 pcs/pack

Code: CTP118



فوط تنظيف
Kitchen Cloth - Premium
Size: 50x70cm

Packing: 1x12 pcs/pack

Code: OM226

Code: FWIC101



منفضة ريش نعام بيد بلاستيك / خشب
و منفضة ريش ملونة
Feather Duster with wooden Handle & Magic Duster

Packing: Each

Code: SJPC101-104



زجاجات رش بلاستيك فارغة
Empty Spray Bottle
500ml / 750ml Capacity

Packing: Each

Code: RSR



دوسات أبواب / عدة أشكال
Door Mats - Rubber & Coir

Size: (45x120)cm



Rubber Floor Mat
دوسات أبواب / عدة أشكال

Size: (65 x 45) cm.



Rod Floor Mat
دوسات أبواب / عدة أشكال

Size: (60 x 40)cm.

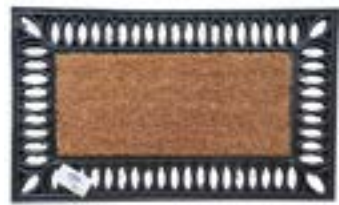

Majestic Floor Mat
دوسات أبواب / عدة أشكال

Size: (45x75)cm

Code: NSIF101-103



Cloth Dryer Aluminium
منشر غسيل المنيوم

Packing: Each

Code: NSIF105-109



منشر غسيل ستانلس ستيل
Cloth Dryer Stainless steel

Packing: Each

Code: SEGT101-103



طاوولات الكوى
Ironing Boards - Small/Medium/Large

Packing: Each

Code: ZBEC107-112



Aluminium Extension Ladder

Aluminium Ladders 3-9 Steps

سلم الومنيوم ٩-٣ درجات

Packing: Each



عربات التنظيف Trolleys

Code: RDSITE101



سطل تنظيف مفرد بلاستيك مع عصارة
Single Bucket Trolley Plastic Complete
ECOMIX BLACK IS GREEN

Packing: Each

Code: RDSITE104



عربة التنظيف المزدوجة بلاستيك - كامل
Double Bucket Trolley with Bag - Complete
REVOLUTION BLACK IS GREEN

Packing: Each

Code: RDSITE105



عربة مزدوجة الجردل بلاستيك مع سلة - إيطالي
Double Bucket Trolley Plastic - Complete
BLACK IS GREEN

Packing: Each

Code: RDSITE138



عربة مفردة كروم - إيطالي
Single Bucket Trolley Chrome-Complete

Packing: Each

Code: RDSITE137



عربة مزدوجة الجردل كروم - إيطالي
Double Bucket Trolley Chrome-Complete

Packing: Each

Code: UPTT147



عربة مزدوجة الجردل كروم - تركي
Double Bucket Trolley Chrome - Complete

Packing: Each

Code: UPTT146



عربة مفردة مع عصارة
Single Bucket Trolley Chrome

Packing: Each



عربة مزدوجة الجردل كروم - إيطالي
Double Bucket Trolley Chrome-Complete

Packing: Each

Code: GBCTE152



عربة تنظيف مفردة مع عصارة
Single Bucket Trolley Plastic -Yellow

Packing: Each

Code: GBCTE140-143



عربة ميني باكيت مع عصارة عدة الوان
Mini Mop Bucket 20Ltr

Packing: Each

Code: UPTT114



سطل مسح الأرضيات مع عصارة
Mop Pail Spin Jet / Mop Pail

Packing: Each

Code: RDSITE115



عصاره بلاستيك
Wringer Plastic

Packing: Each

Code: RDSITE129



عربة تجميع نفايات بغطاء ودعسة
Polypropylene Waste Collection Trolley
Size: 51 x 50 x 94 cm

Packing: Each

Code: RDSITE136



عربة مواد آمنة انترس S7
Janitorial Security Trolley - ANTARES S7
Size: Cm 68x124.5x118 h

Packing: Each

Code: GBCTE149



عربة مواد وأدوات تنظيف - صيني
Multi-Functional Trolley

Packing: Each

Code: RDSITE135



عربة مواد وأدوات تنظيف - إيطالي
Janitorial Trolleys - ACE 20
Size: 68 x 83 x 103 H. Cm

Packing: Each

Code: UPTT132



عربة مواد وأدوات تنظيف - تركي
Waste Collection Trolley
Size: 110X70X107 H.Cm.

Packing: Each

Code: UPTT130



عربة مواد وأدوات تنظيف - تركي
Janitorial Trolley Single Bucket with bag holder

Packing: Each

Code: UPTT131



عربة مواد وأدوات تنظيف - تركي
Janitorial Trolley Double Bucket with bag holder

Packing: Each

Code: UPTT137



عربة مواد وأدوات تنظيف - تركي
Janitorial Trolley - KA605JK Turkey
Size: 97x62.5x110H.Cm.

Packing: Each

Code: RDSITE134



عربة مواد وأدوات تنظيف - إيطالي
Janitorial Trolleys - ACE 7
Size: 68 x 120 x 103 H. cm

Packing: Each

Code: UPTT133



عربة مواد وأدوات تنظيف - تركي
Janitorial Trolley - KA405FK Turkey
Size: 133X62.5X110 H.Cm.

Packing: Each



عربة مواد تنظيف مع خزانات
Waste Collection Trolley - Brix Premium
Size: 610 x 1660 x 1040H.Cm.

Packing: Each

Code: UPTC101



عربة مواد تنظيف مع خزانة
Herculers Nano Cabinet - HND992
Size: 140X53X100 H. Cm.

Packing: Each



عربة مواد تنظيف مع خزانات
Service Trolley - Brix PT Suite
Size: 610 x 1245 x 1110H. Cm.

Packing: Each

Code: GBCTE148



عربة تجميع الغسيل
X-Frame trolley

Size: 68 x 59 x 105 cms

Code: UPTT113



عربة تجميع المخلفات 3 أقسام
Compartment Waste Collection Trolley 3
Plastic Frame with Nylon Bags.

Dimensions : 167x57x110cm

Code: UPTT112



عربة تجميع المخلفات 3 أقسام بأبواب
Compartment Waste Collection Trolley with door 3

Dimensions: 167x57x110cm

Code: GBCTE108



حامل مواد تنظيف
Multi-Functional Cleaning Bucket

Size: 38x51.5x28(cm)



Foldable Only 300KG



عربة البضائع
Goods Trolley



عربة لتحميل الأمتعة الفندقية لون ذهبي
Luggage Shifting Trolley

Size: L-1100x-W650x H-1880mm

Code: GBCT106



عربة نقل متعددة المهام
Deluxe Utility cart

Size: 82x41x93(cm)

Code: GBCT105



عربة نقل متعددة المهام
Deluxe Utility cart

Size: 82x41x93(cm)

Code: GBCTE104



عربة تنظيف متعددة المهام
Trolley Multi-Functional Cleaning

Size : 131.2x64.8x131(cm.)



عربة تنظيف مزدوجة للساحات الخارجية
Double Drum Cleaning Cart

Drum Size : 120 / 240 Ltr.

Code: SEW



120 / 240 Ltr.

عربة تنظيف مفردة للساحات الخارجية

Street Cleaning Cart with Canopy

Code: SEW101-102



120 / 240 Ltr.

عربة تنظيف مفردة للساحات الخارجية

Street Cleaning Cart

Code: GASSTE129-135



سطل بلاستيك مدور بغطاء
Plastic Drum with cover
Capacity : 45, 65, 100, 120 & 150Ltr

Packing: Each

Code: GASSTE127



سطل بلاستيك عدة احجام

Plastic Bucket - Capacity : 5, 10, 15, 21 & 23 Ltr

Packing: Each

Code: JFTCT105



سلة قمامة شبك معدنية

Trash Bin Net - Metal

Size: (33x29.5cm)

Code: GASST101-102



سلة قمامة شبك بلاستيكية

Trash Bin Net - Plastic

Size: (D.28 x 27.5cm)



الحاويات Trash Bins

Code: RPTT101 & 104



سلة قمامة معلقة

Trash Bin Wall Mounted - White
Capacity : 25 & 50 Ltrs

Packing: Each

Code: RPTT102 & 103



سلة قمامة معلقة

Trash Bin Wall Mounted - Black
Capacity : 25 & 50 Ltrs

Packing: Each



سلة قمامة معلقة

Trash Bin Wall Mounted
Capacity : 25 ltr

Packing: Each

Code: ZXPCT159

Code: ZXPCT104



سلة قمامة معلقة
Trash Bin Pole Mounted
Capacity : 50 Ltrs

Packing: Each

Code: DMTT101



سلة المهملات مقاومة للحريق
Trash Can Fire Resistant - 38Ltrs

Size: Dia. 30cm x 64cm (H)

Code: GMMPF109



سلة مهملات دائرية بغطاء مروحة
Trash Can Round with Swing Lid - 54Ltrs

Size: Dia. 38 x (H) 73cm

Code: JFTCT101



طفاية سجاائر ستانلس ستيل
Ashtray Bin Stainless Steel, 12Ltrs

Size: Height: 60.5cm x Dia: Ø 25cm

Code: DMTT119



طفاية سجاائر ستانلس ستيل
Ashtray Bin Stainless Steel, 12Ltrs

Size: Height: 60cm x Dia: Ø 22cm

Code: FHTT104



طفاية سجاائر ستانلس ستيل
Ashtray Bin Stainless Steel, 12Ltrs

Size: Height: 61cm x Dia: Ø 25cm

Code: GMMPF111

Code: GMMPF110

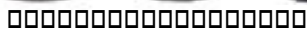

Trash Can Round with Swing Lid

Packing: Each

Code: DMTT105-109

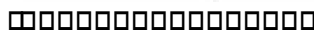

Trash Bin with Pedal St/Steel
Capacity : 5, 12, 20 & 30Ltrs

Packing: Each

Code: GMMPF104-107



Trash Bin with Pedal Heavy Duty - St/Steel

Capacity : 12, 20 & 30Ltrs

Code: JFTCT108 50L

Code: FHTT103 32L



حاوية قمامة ستانلس ستيل
Trash Can Stainless Steel - Push Lid 32 & 50Ltrs

Packing: Each

Code: GMMPF121



Soft Closing



سلة مكتبية ستانلس ستيل بدعسة
للأستخدام الشاق
Heavy Duty Pedal Dust Bin St/Steel

Capacity : 20Ltrs

Code: GBCT105-107



سلة فصل المخلفات بدعسة
Foot Classification Garbage Bin.
Capacity : 20L, 40L & 60L.

Packing: Each

Code: JFTCT108



سلة لفرز المخلفات بدعسة 3 حوض
Recycling Bin with Pedal 3 Compartment
3x8ltr and 3x15ltr

Packing: Each

Code: GMMPF121



دram قمامة بلاستيك لاعادة تدوير النفايات
Recycling Bin with Wheel Base 60 ltr.

Packing: Each

Code: GBCT105-107



دram قمامة بلاستيك لاعادة تدوير النفايات
Recycling Bin Push Type 60 ltr.

Packing: Each

Code: GMMPF103



حاوية قمامة خارجية
Capacity 42 Ltrs
Size: 400 x 400 x 950mm

Packing: Each

Code: GMMPF108

OUTDOOR



Recycling Waste Bin
Material: 304 stainless steel with
powder-coated
frame & WPC wood slats
Thickness: 0.8mm thick

حاوية قمامة خارجية
Capacity 40 Ltrs
Size: 400 x 400 x 950mm

Packing: Each

Code: GMMPF113



حاوية معدنية لفصل المخلفات
Recycling Waste Bin

Size: 610x360x760mm

Code: 68301, 68302, 68303, 68304



Size - 36 x 29 x h50cm
Color : Green - Yellow - Blue - Red

Sort Bin 28L, Recycling Bin, Trash Bin

Code: 68001, 68002, 68003, 68004



Size - 40 x 34 x h61cm
Color : Green - Yellow - Blue - Red

Sort Bin 45L, Recycling Bin, Trash Bin

Code: 70501, 70502, 70503, 70504



Size - 40,5 x 53 x h85,5 cm
Color : Green - Yellow - Blue - Red

Sort Bin 90L, Recycling Bin, Trash Bin

Code: 70700, 70701, 70702, 70703, 70704



Size - 53 cm x h82 cm
Color : Green - Yellow - Blue - Red - Silver

Quatro Recycling Bin 90L

Code: 65002, 65003, 65005



Size - 41 x 41 x h59,5cm
Color : Green - Blue - Silver - Steel

Eco Recycling Bin 50L

Code: 71401, 71402, 71404



Size - 26,5 x 23,5 x h51cm
Color : Black Red - Black Green - Black Yellow

Recycling Bin 20L

Code: 72001, 72002, 72004



Size - 33 x 33 x h73cm
Color : Black Red - Black Green - Black Yellow

Recycling Bin 53L

Code: 72001, 72002, 72004



Size - 39x39 x h73
Color : Black Red - Black Green - Black Yellow

Recycling Bin 75L

Code: 80301



Size - 40,5 x 53 x h75cm

Duo Bin, Recycling Bin, Trash Bin - 90L

Code: 82301



Sort Bin Metal Base 3x20L

Size : 49 x 27 x h7,5 cm

Code: 82501



Sort Bin Metal Base 3x53L

Size : 69 x 34 x h7,5 cm

Code: 82401



Sort Bin Metal Base 3x75L

Size : 79 x 39 x h8,5 cm

Code:



Size - L485*W485*H937mm
Color : Black Gold

Indoor Trash Bin, Stainless Steel, Removable Ashtray

Code:



Size - (33x29.5)cm
Color : White

Garbage Bin Steel Net

Code:



Size - 284x286x127mm
Color : White

Plastic Sanitary Fem Bins with Pedal - 18L

Code:



Size - 480*H850mm
Color : Black

Metal Trash Can, Litter Bin Recycle Bin - 30L

Code : 60905



Size - 35,7 x 29,3 x h54,1 cm
Color : White

Bin Standard - White - 30L

Code : 60902



Size : 35,7 x 29,3 x h54,1 cm
Color : Graphite

Bin Standard, Graphite - 30L

Code:



Size - 22×28 cm

Open Lid Bins – 8Ltr

Code:



Size - 18×26 cm

Open Lid Bins – 5Ltr

Code:



Size - 22×32,5 cm

Open Lid Bins – 12Ltr

Code:



Size - 50-33-98cm
Color : White & Black

Street Metal Rubbish, Recycling Bin, Garbage Bin - 60L

Code:



Size - 380*H730mm
Color : Brushed

Indoor Trash Can, Recycle Trash, Waste Office Bin - 54L

Code: KPT101



Recycling Waste Bin, 4 Compartments
Capacity: 4 x 70Ltr.
Size: L-360 x W-400 x H-720 mm(Each).

Packing: Each

Code: GMMPF116



Recycling Waste Bin
حاوية معدنية لفصل المخلفات

Size: 1000 x 430 x 910mm

Code: GMMPF114



حاوية قمامة خارجية
Recycling Waste Bin
Capacity 120 Ltrs

Size: 940 x 380 x 760mm

Code: GMMPF118



حاوية قمامة خارجية
Recycling Waste Bin
Capacity 45x3 Ltrs

Size: 940 x 360 x 760mm

Code: GMMPF117



حاوية معدنية لفصل المخلفات
Recycling Waste Bin
Capacity 45x4 Ltrs

Size: 1200 x 360 x 760mm



SN109B
Airport Recycle Waste Bins

Code: ZXPCT102-103



سلة قمامة بغطاء متحرك
Garbage Bin with Moving lid
Capacity : 20 , 30 & 40 Ltrs

Packing: Each



دram قمامة مع قاعدة بعجلات
Garbage Container with wheel base
80, 120 & 168 ltr.

Packing: Each

Code: GBCT101,102,112,126,128,132,133,134



دram قمامة بدعسة أحجام مختلفة
Pedal Dust Bin Plastic
Capacity : 30, 45, 50, 68, 70 & 87 Ltr

Packing: Each

Code: GBCT114-115



دram قمامة مع قاعدة بعجلات
Garbage Container with wheel base
60 & 100 ltr.

Packing: Each

Code: ZXPCT114-119



Foot pedal To open lid

Pedal Dust bin, Plastic - 70Ltrs

دram قمامة بعجلات ودعسة ٧٠ لتر



Size: L555xW518xH750 mm

Code: ZXPCT153-158



درام قمامة بعجلات ٥٠ لتر
Garbage Bin with wheels & lid 50 ltr.

Packing: Each

Code: ZXPCT121-126



Garbage Bin with wheels & lid 100 ltr.

L56.4xW48.2xH84.8 cm

درام قمامة بعجلات ١٠٠ لتر

Packing: Each

Code: GBCT121-123



Foot pedal To open lid



Pedal Dust bin with wheels & lid - 120Ltrs

L55.5xW47.6xH95.7 cm

درام قمامة بعجلات ودعسة ١٢٠ لتر

Packing: Each



Code: ZXPCT127-133



Garbage Bin with Wheels & Lid 120 Ltr

L55.5xW47.6xH95.7 cm

درام قمامة بعجلات ١٢٠ لتر

Packing: Each

Code: ZXPCT134-137



Garbage Bin with Wheels & Lid 240 Ltr

L72.5xW58.5xH109 cm

درام قمامة بعجلات ٢٤٠ لتر

Packing: Each

Code: ZXPCT127-133



Wheeled Dustbin , Garbage Bin with Wheels & Lid 240 Ltr
Dimension : L 725.5 x W58.5x H 109 cm

Packing: Each

Galvanized Containers 1100Ltrs

Code: ZXPCT101



Code: ZXPCT143



ZTL-1100A L136.0 x W103.0 X H129.0 cm

ZTL-660A L133.5 x W77.0 X H123.5 cm

حاوية قمامة بعجلات

Garbage Drum with Wheels & Lid 660 Ltr. & 1100 Ltr.

Packing: Each



GALLERY



حاوية قمامة شكل قلم Litter Bin - Pencil



Capacity
70
Litres

Specifications

Dimensions: H:1100 x Dia:460mm
Capacity: 70 litres
Steel Liner: Optional (70 litre)
Plastic Liner: Optional (70 litre)

Design Features

- Suitable for internal or external use.
- Hooded bin to prevent rain water gathering in the bin
- Tough, durable and weather resistant material
- Aperture is easy to access for children
- Super strong and durable Plastic (same materials used to make canoes!
- Can be grouped neatly together for space saving.

Optional Extra

- Fixing Kit: Optional
- Lock: Optional
- Label: Optional (WRAP compliant waste stream) Label and colour
- customisation: Optional

Materials

UV stabilised medium density moulded polyethylene (MDPE)

Packing: Each

Capacity
70
Litres



حاوية قمامة شكل فرس النهر Litter Bin - Hippo

Design Features

- Suitable for internal or external use
- Choice of colours; Henrietta (Pink), Henry (Blue), Harriett (Orange), Hugo (Green)
- Ideal for use in a variety of locations including leisure centres and swimming pools
- Twist off lid for easy access to liner

Optional Extra

- Anchor Plate: Included
- Lock: Included
- Fixing Kit: Optional

Materials

Materials: UV stabilised medium density moulded polyethylene (MDPE)

Specifications

Dimensions: H:1100 x Dia:700mm
Capacity: 70 litres
Steel Liner: Optional (70 litre)
Plastic Liner: Optional (70 litre)

Packing: Each

حاوية قمامة أشكال مجسمة للأطفال Litter Bin - AquaBuddy

Design Features

- Suitable for internal and external use
- Slimline, compact and space saving design
- Ideal for medium volume waste recycling.

Optional Extra

- Choice of ground fixing.

Materials

UV stabilised medium density moulded polyethylene (MDPE)

Specifications

PenguinBuddy

Dimensions: H:805, W:595,
Dia:515mm
Capacity: 55 litres

DolphinBuddy

Dimensions: H:825, W:595,
Dia:530mm
Capacity: 55 litres
Plastic Liner: Included (55 litre)

Capacity
85/100
120
Litres



FrogBuddy

Dimensions: H:850, W:595, Dia:515mm
Capacity: 75 or 84 litres
Plastic Liner: Optional (75 litre)
Sack Retention: Optional (84 litre)

Packing: Each



حاوية لفرز المخلفات للمطاعم Meridian Envirobin 110: Triple

Specifications

Dimensions: H:852mm W:600mm
D:400mm
Height including signage: 1460mm

Capacity: 33 litres, 44 litres and either
33 litres of chosen waste or 9.5 litres
of liquids



Design Features

- Narrow footprint allowing it to fit comfortably in corridors without reducing access.
- Includes FREE A3 signage kit (poster not included)
- Suitable for internal use
- Interchangeable lids & slim body profile
- WRAP compliant colour coded apertures and graphics

Materials

- Materials: UV stabilised medium density moulded polyethylene (MDPE)
- Sack retention bands: PVC
- Bin Linking Kit: Optional

Packing: Each

حاوية لفرز المخلفات للمطاعم Envirobin 100: Split Bin Range

Design Features

- Suitable for internal use
- Ideal for high volume waste recycling
- Sack retaining feature for discreet fitting of refuse bag
- Use individually or in a group
- Robust double wall lid for ultimate rigidity and durability
- Interchangeable lids

Materials

UV stabilised medium density moulded polyethylene (MDPE)

Specifications

Dimensions: H:803mm,
W:445mm, D:445mm
Label: Included



Packing: Each



EnviroGo: PPE Bin

Design Features

- Suitable for internal use
- Slimline, compact and space saving design
- Ideal for low volume waste recycling
- Use individually at desk side or in a group
- Interchangeable lids

Specifications

Dimensions: H-974, W-600, D-355mm
Capacity: 90 litres

Materials

UV stabilised medium density moulded polyethylene (MDPE)



حاوية صغيرة لفرز المخلفات Envirobin Mini



Specifications

Dimensions:
H-660mm, W-302mm, D-523mm
Capacity: 55 litres

Packing: Each

حاوية قمامة خارجية كلاسيك مع طفاية سجاير

Classic Litter Bin

Code: LE110

Capacity
90/105
Litres



Black
base made
from 100%
recycled
plastic

Design Features

- Classic styling suitable for a range of situations
- Double aperture providing easy 'walk by' access
- Anti-fly poster dimpled surface
- Two panels for personalised labels
- Lift off lid for easy, all round, access to liner

Specifications

Dimensions: H:1070 x Dia:570mm
Capacity: 90 to 105 litres
Label: Optional (front and back
197.5 x 245.5 mm)

Materials

UV stabilised medium density
moulded polyethylene (MDPE)

Packing: Each

حاوية قمامة خارجية صغيرة مع طفاية سجاير

Mini Classic Litter Bin

Code: LE108

Design Features

- Classic styling suitable for a range of situations
- Double aperture providing easy 'walk by' access
- Anti-fly poster dimpled surface
- Two panels for personalised labels
- Lift off lid for easy, all round, access to liner

Specifications

Dimensions: H: 950 x Dia: 465mm
Capacity: 60 to 70 litres
Label: Optional (front and back
197.5 x 245.5 mm)

Materials

UV stabilised medium density
moulded polyethylene (MDPE)



Capacity
60/70
Litres

Packing: Each

Capacity
85
Litres

Litter Bin Heritage Round

حاوية قمامة دائرية بشكل تراثي

Code: LE106



Design Features

- Classic styling suitable for a range of situations
- Double aperture providing easy 'walk by' access
- Secure key locking facility
Lift off lid for easy, all round, access to liner
- Integral ballast cartridge as standard
- Gold banding and lock included

Specifications

Dimensions: H:1118, W:579,
D:579mm

Capacity: 85 litres

Materials

UV stabilised medium density
moulded polyethylene (MDPE)

Black
base made
from 100%
recycled
plastic

Litter Bin Heritage Square

حاوية قمامة خارجية مربعة مع طفاية سجاير

Code: LE109

Black
base made
from 100%
recycled
plastic

Design Features

- 130 litre bin volume
- 110 litre liner capacity
- 4 way apertures providing all round access
- Enhanced double wall structure for ultimate rigidity and durability
- Slam shut door with four point latch for extra security
- Anti-fly poster ribbed surface to deter fly posting
- Diagonal hinged door for easy access, no lifting required

Specifications

Dimensions: H:1118, W:579,
D:579mm

Capacity: 110 litres

Materials

UV stabilised medium density
moulded polyethylene (MDPE)



Capacity
110
Litres

Packing: Each

حاوية قمامة مزدوجة الفتحات
Smart E-Consort Litter Bin



Capacity
85/100
Litres

Specifications

Dimensions: H:1075, Dia: 560mm
Capacity: 85/100 litres

Black
base made
from 100%
recycled
plastic

Materials

UV stabilised medium density
moulded polyethylene (MDPE)

Packing: Each

حاوية قمامة مزدوجة الفتحات
Consort Litter Bin

Black
base made
from 100%
recycled
plastic



Capacity
85/100
Litres

Specifications

Dimensions: H:1075, D:560mm
Capacity: 85/100 litres

Materials

UV stabilised medium density
moulded polyethylene (MDPE)

Packing: Each

حاوية قمامة بقبة علوية Metro Dome Litter Bin



Specifications

Dimensions: H:1075, D:560mm

Capacity: 85/120 litres

Materials

UV stabilised medium density moulded polyethylene (MDPE)

Packing: Each

حاوية قمامة بقبة علوية Heritage Dome Litter Bin



Specifications

Dimensions: H:981, D:522mm

Capacity: 110/130 litres

Materials

UV stabilised medium density moulded polyethylene (MDPE)

Packing: Each

حاوية قمامة خارجية

Litter Bin Pioneer



Design Features

- Double apertures providing easy 'walk by' access
- Moulded aperture directs waste into the liner
- Enhanced double wall structure for ultimate rigidity and durability
- Dimpled surface to deter fly posters
- Slam shut door with four point latch for extra security
- Front opening door for easy access, no lifting required

Black base made from 100% recycled plastic

Specifications

Dimensions: H:1170, W:680, D:570mm
Capacity: 110 to 130 litres
Materials:
Steel Liner: Optional 110 litres
Plastic Liner: Optional 130 litres
Ground Fixing Kit: Optional

Capacity
110/130
Litres



Materials

UV stabilised medium density moulded polyethylene (MDPE)

Packing: Each

حاوية لجمع الورق

Envirobin 100



Capacity
100
Litres

Specifications

Dimensions:
H: 803mm, W: 445mm, D: 445mm
Capacity: 100 litres
Lock: Included

Envirobin Maxi Confidential Waste

- Suitable for internal use
- Ideal for high volume waste recycling
- Sack retaining feature for discreet fitting of refuse bag
- Use individually or in a group
- Robust double wall lid for ultimate rigidity and durability
- Interchangeable lids

Black base made from 100% recycled plastic



Capacity
140
Litres

Specifications

Dimensions: H: 1220, W: 550, D: 615mm
Capacity: 140 litres
Lock: Included
Ground Fixing Kit: Optional

Envirobin Mini/ Midi Confidential Paper



Capacity
82
Litres

Specifications for Mini

Dimensions: H: 660mm, W: 302mm, D: 523mm
Capacity: 55 litres

Specifications for Midi

Dimensions: H: 866mm, W: 302mm D: 541mm
Capacity: 82 litres

Packing: Each

Envirobank 240 Recycling Bin

حاوية لجمع الورق

Specifications

Dimensions: H:1491, W:741, D:871mm
Capacity: 240 to 320 litres
Ground Fixing Kit: Optional
Empty Ballast Cartridge: Standard
Lock: Included

Design Features

- Suitable for internal and external use
- Front opening design allows emptying without lifting
- Slam shut door with 4 strong latch points
- Heavy duty, automotive grade, tamper-proof lock
- Stubber Plate
- Upgraded tamper-proof lock
- Whisper-Close Aperture Flap (wasp deterrent)
- A3 Poster Frame (poster not included)

Materials

UV stabilised medium density moulded polyethylene (MDPE)



Black base made from 100% recycled plastic

Capacity
240/320
Litres

Packing: Each

Envirobank 140 Recycling Bin

حاوية لجمع الورق

Design Features

- Suitable for internal and external use
- Front opening design allows emptying without lifting
- Slam shut door with 4 strong latch points
- Heavy duty, automotive grade, tamper-proof lock

Materials

UV stabilised medium density moulded polyethylene (MDPE)



Black base made from 100% recycled plastic

Specifications

Dimensions: H:1398, W:651, D:669mm
Capacity: 140 to 225 litres
Ground Fixing Kit: Optional



Packing: Each

Envirobank Recycling Bins

حاويات لفصل المخلفات



Black base made from 100% recycled plastic

Packing: Each

جهاز تعقيم الأحذية من الاسفل

Steri Job (Footwear Sanitizer)

Code: GAMM101

For use in: Hospitals, Food factories, Dairies, Catering companies.

Description: The atomiser STERJOB is especially designed for a quick and safe sanitization of footwear.

Operation: Get on the ramp and place your feet on the grill to start the atomisation of the antibacterial solution through the vicinity sensor. The atomisation process automatically stops after a few seconds

Supply Voltage: 220/110 V

Working Voltage: 24 v

Tank Capacity: 5000 cc

Working Pressure: 2-4 Bar

Weight: 55 Kg

Overall Dimensions: 1563x780x400 mm



معدات التعقيم

Steam Machines

Sanitizing Machines

High Pressure Washers

Steri Jet (Foot Sanitizer)

جهاز تعقيم الأرجل

Code: GAMM105



Refill Cartridge
available in
1 Ltr and 5 Ltrs

Functioning:

Rest the foot or the footwear on the proper opening and work the vaporization process by simply putting pressure on the switch on the knob

Accessories on Request:

Movable Support

Sterilization Speed: 3÷5 Sec

Supply Voltage:

115/230v - 50/60 hz

Working Voltage: 12v

Tank Capacity: 2000 cc

Electrical Input: 40 w

Weight: 7,5 kg

Code: JMAB102



SWITCH TANK™ 15L CHEMICAL SPRAYER

ماكينة تنظيف بالبخار

Specifications		المواصفات
Capacity (l)	15	سعة تانك السائل
Flow rate (l/min)	0.4 – 2.0	معدل الرش
Hose length (m)	1.75	طول الهوز
Pressure (bar)	8,27	الضغط
Spray distance (m)	7.6	ضغط البخار
Voltage (V)	18	الفولت
Weight (kg)	3.6	الوزن
Battery type	Li-ion	نوع البطاريات



Code: SMBKM101



GV Kone STEAM CLEANER

ماكينة تنظيف بالبخار

Code: LWI113

Specifications		المواصفات
Absorbed power	2300W / 220-240v ~ 50Hz	قوة امتصاصها
Pressure / temperature max	4 bar/143 °C bar/°C	الضغط / درجة الحرارة ماكس
Steam production	80 kg/H	كمية البخار المنتج
Type / volume boiler	Alluminium/2,4l	نوع / حجم المرجل
Vacuum motor	- W	موتور الشفط
Activation time	10 min.	الوقت التنشيط
Air suction	- m3/h	شفط الهواء
Electric cable length	6 m	طول الكابيل الكهربائي
Noise level	< 80 dB (A)	مستوى الضوضاء
Dimensions/Weight	-	الأبعاد / الوزن
Tank capacity water/detergent	-	سعة خزان المياه / المنظفات

CTM GV KATLA STEAM GENERATORS

ماكينة تنظيف بالبخار

Code: LWI114

Specifications		المواصفات
Absorbed power	3,3 Kw/230 W-50 Hz 1Ph kW/V-Hz Ph	قوة امتصاصها
Pressure / temperature max	9 bar/175 °C bar/°C	الضغط / درجة الحرارة ماكس
Steam production	4.62 kg/H	كمية البخار المنتج
Type / volume boiler	inox AISI 304/18 l.	نوع / حجم المرجل
Vacuum motor	- W	موتور الشفط
Activation time	7 min.	الوقت التنشيط
Air suction	- m3/h	شفط الهواء
Electric cable length	6 m	طول الكابيل الكهربائي
Noise level	< 80 dB (A)	مستوى الضوضاء
Dimensions/Weight	540x600x900 mm/19 Kg mm/kg	الأبعاد / الوزن
Tank capacity water/detergent	5/5 l.	سعة خزان المياه / المنظفات



ماكينة توليد بخار

Code: BF60100000

Specifications		المواصفات
Electric source	220v/110v/12v with inverter	مصدر كهربائي
Connected Load	350 W	تحميل متصل
Fuel	45 ltrs.	خزان الوقود / خزان المياه
Burner Fuel	Diesel	الموقد الوقود
Electric Consumption	150w	استهلاك الوقود
Pre-heating time	25 min.	الوقت قبل التدفئة
Steam Production	42 kg/h	كمية البخار المنتج
Steam Pressure	9.5 - 10.5 bar	ضغط البخار
Steam Temperature	150°C	درجة الحرارة البخار
Machine dimensions	100x70x90 cm	أبعاد الجهاز
Machine weight	110Kg	وزن الجهاز

High Pressure Washer Machine

مضخات غسيل الضغط العالي

HEAVYPRO
88 SERIES



ANNOVI REVERBERI
MADE IN ITALY

Code: ARI109



Ergonomic handle

Water tank with float switch

Rubber wheels

Warning lights: power on, fuel, flame water temperature control thermostat

Stainless steel boiler

Inspectable water intake filter

General Features:

- Triplex pump with ceramic pistons and connecting rod system
- Automatic by-pass valve with pump head pressure discharge
- Heavy-duty three-phase motor with thermal protector
- Remote control for total shut-down of high pressure cleaner
- With safety pressure switch to shut down the boiler in case of lack of water
- Stainless steel vertical boiler with coil burner cooling function driven by independent motor, double coil and refractory cement bottom
- Minor leak detector PCB with buzzer
- Heating boiler shut-down delay circuit
- Pressure adjustment built-in
- Diesel tank with drain plug (24 l)
- Thermostat
- Built-in detergent suction
- Built-in detergent tank capacity 8 l
- Water filter and fuel inlet filter
- Electric cable length 10 m

Standard accessories



--	--	--	--	--	--	--	--	--

bar	psi	l/h	gph	kW	rpm	Hz	V	kg
200	2900	1260	333	9.3	1450	50	400 3~	135

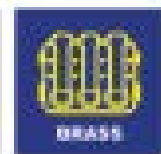
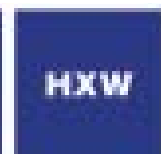

High Pressure Washer Machine

مضخات غسيل الضغط العالي

HEAVYPRO
66 SERIES



Code: ARI108

Stainless steel boiler

Ergonomic handle

Thermostat (equipped with)

Inspectable water intake filter

Front castor wheel

Rubber wheels



General Features:

- Triplex pump with ceramic pistons and connecting rod system
- Automatic by-pass valve with pump head pressure discharge
- Heavy-duty motor with thermal protector • With safety pressure switch to shut down the boiler in case of lack of water
- Coated steel vertical boiler with coil burner cooling function driven by independent electric motor, double coil and refractory cement bottom
- Heating boiler shut-down delay circuit • Pressure adjustment built-in
- Diesel tank with drain plug (22 l)
- Thermostat
- Built-in detergent suction
- Built-in detergent tank capacity 3.5/4 l • Water filter and fuel inlet filter
- Electric cable length 5 m

Standard accessories



bar	psi	l/h	gph
170	2500	780	206
kW	rpm	Hz	V
5	1450	50	400 3-
kg			
85			

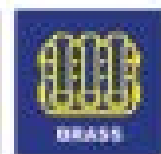

High Pressure Washer Machine

مضخات غسيل الضغط العالي

386

Cold Water

Manufactured by
ANNOVI REVERBERI
ITALY in PRC

Code: ARI110



General Features:

- Two-wheel trolley with handle and hose reel (6 m HP hose)
- 3 Axial stainless steel pistons wobble-plate pump with aluminium head
- Tempered stainless steel pistons
- Automatic by-pass valve with pump head pressure discharge
- Motor thermal protector
- Built-in detergent tank for direct suction • Detergent tank capacity 1.4 l
- Electric cable length 5 m

Standard accessories



MAX		MAX		MAX		NET	
bar	psi	l/h	gph	kW	Hz	V	kg
130	1885	420	110	1.7	50-60	220-240	10.6



High Pressure Washer Machine

مضخات غسيل الضغط العالي

● **3 SERIES**

396



Manufactured by
ANNOVI REVERBERI
ITALY in PRC

Code: ARI107

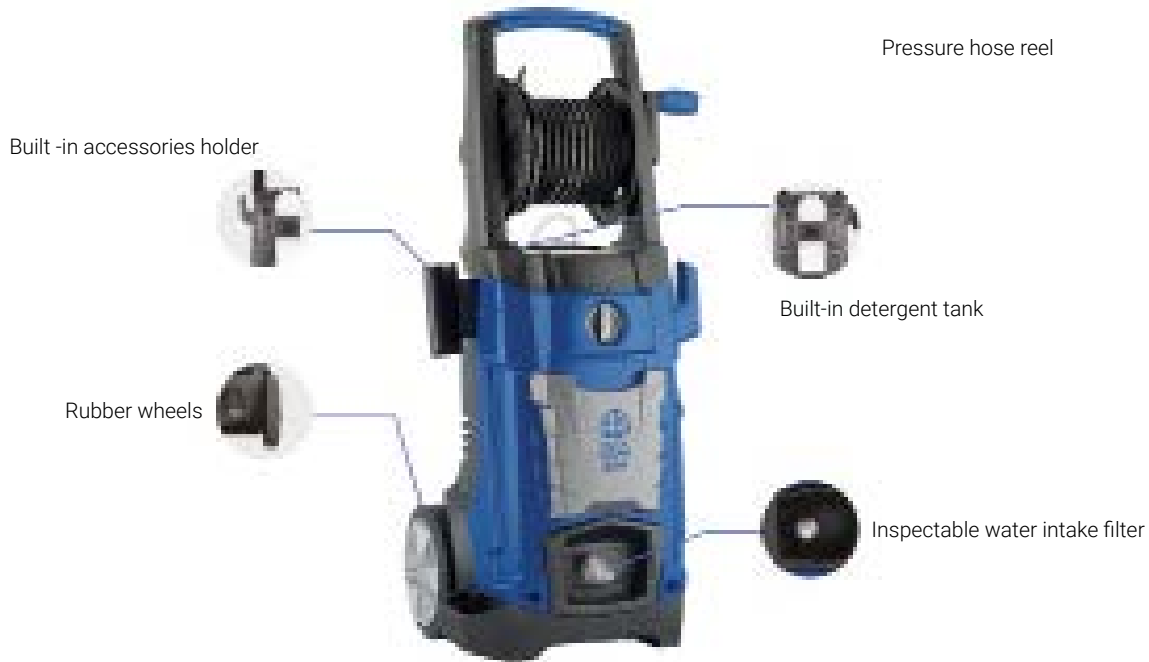

General Features:

- Two-wheel trolley with handle and hose reel (6 m HP hose)
- 3 Axial stainless steel pistons wobble-plate pump with aluminium head
- Tempered stainless steel pistons
- Automatic by-pass valve with pump head pressure discharge
- Motor thermal protector
- Built-in detergent tank for direct suction • Detergent tank capacity 1.4 l
- Electric cable length 5 m

Standard accessories



MAX	MAX						NET
bar	psi	l/h	gph	kW	Hz	V	kg
160	2320	440	116	2	50-60	220-240~	13,4



High Pressure Washer Machine

مضخات غسيل الضغط العالي

● 1 SERIES

117

 Cold Water

Manufactured by
ANNOVI REVERBERI
ITALY in PRC

Code: ARI104



General Features:

- 3 Axial stainless steel pistons wobble-plate pump with aluminium head
- Tempered stainless steel pistons
- Automatic by-pass valve with pump head pressure discharge
- Motor thermal protector • Electric cable length 5 m

Standard accessories



 MAX		 MAX					 NET
bar	psi	l/h	gph	kW	Hz	V	kg
110	1600	390	103	1,3	50-60	220-240~	5,6



High Pressure Washer Machine

مضخات غسيل الضغط العالي

● 1 SERIES

143

Cold Water

Manufactured by
ANNOVI REVERBERI
ITALY in PRC

Code: ARI106



General Features:

- Two-wheel trolley with handle
- 3 Axial stainless steel pistons wobble-plate pump with aluminium head
- Tempered stainless steel pistons
- Automatic by-pass valve with pump head pressure discharge
- Motor thermal protector
- Electric cable length 5 m

Standard accessories



MAX		MAX		MAX			KG NET
bar	psi	l/h	gph	kW	Hz	V	kg
120	1740	390	103	1,5	50-60	220-240~	5,9



High Pressure Washer Machine

مضخات غسيل الضغط العالي

● 5 SERIES

591

Cold Water

Manufactured by
ANNOVI REVERBERI
ITALY in PRC

Code: ARI105



General Features:

- Two-wheel trolley with handle and hose reel (Reinforced 10 m HP hose)
- 3 Axial stainless steel pistons wobble-plate pump
- Tempered stainless steel pistons
- Automatic by-pass valve with pump head pressure discharge
- Pressure gauge
- Single-phase induction motor with thermal protector
- Built-in detergent tank for direct suction
- Electric cable length 5 m
- Pressure adjustment

Standard accessories



MAX		MAX		MAX			KG NET	
bar	psi	l/h	gph	kW	rpm	Hz	V	kg
180	2600	600	159	2,8	2800	50	220-230~	25



High Pressure Washer Machine

مضخات غسيل الضغط العالي

HEAVYPRO
9 SERIES 930

Cold Water

ANNOVI REVERBERI
MADE IN ITALY

Code: ARI103



General Features:

- Two-wheel trolley unit with handle
- Triplex pump with ceramic pistons and connecting rod system
- Automatic safety valve with pressure shut-off at pump head
- Single-phase induction motor with thermal protection
- Pressure adjustment
- Pressure gauge
- Built-in detergent suction
- Adjustable detergent injector • Electric cable length 5 m

Standard accessories



MAX	MAX							NET
bar	psi	l/h	gph	kW	rpm	Hz	V	kg
150	2200	630	166	3	1450	50	230-	43,6



High Pressure Washer Machine

مضخات غسيل الضغط العالي

DTS SERIES 5.0 TWIN FLOW

Cold Water

Manufactured by
ANNOVI REVERBERI
ITALY in PRC

Code: ARI102



General Features:

- Two-wheel trolley with handle and in-pressure hose reel (8m HP hose)
- Two 3 Axial stainless steel pistons wobble- plate pumps
- Tempered stainless steel pistons
- Automatic by-pass valve with pump head pressure discharge
- Twin single-phase universal motor with thermal protector
- Electric cable length 5m
- Twin nozzle system with double rotary nozzle - Multifunction 5 in 1 nozzle



Standard accessories



bar	psi	l/h	gph	kW	Hz	V	kg
160	2300	850	225	2,7	50-60	220-230~	14,6



High Pressure Washer Machine

مضخات خسيل الضغط العالي

DHS SERIES 2.A

Cold Water

Manufactured by
ANNOVI REVERBERI
ITALY in PRC

Code: ARI101



General Features:

- Two-wheel trolley with handle and static hose reel (6 m HP hose)
- Washing lance
- Spraying lance
- 3 Axial stainless steel pistons wobble-plate pumps
- Tempered stainless steel pistons
- Automatic by-pass valve with pump head pressure discharge
- Universal motor and electric single-phase vibrating pump.
- Electric cable length 5 m

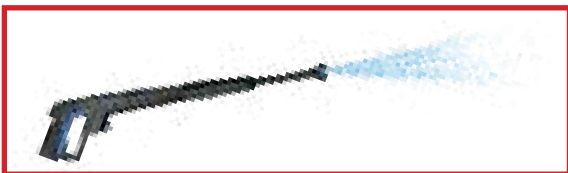

Standard accessories



	bar	psi	l/h	gph	kW	Hz	V	kg
SPRAYING MODE	4	58	0,3	0,08	0,035	50	220-240~	10,55
WASHING MODE	160	2320	460	122	2,2	50	220-240~	





Code: EVWD101 BATTERY OPERATED

Code: EVWD102 MANUAL OPERATED

عربة غسيل السيارات المتنقلة PORTABLE CAR wash cart Go Clean...Go Green

Specifications		المواصفات
Brand	CleanPlus	ضغط التشغيل (كحد أقصى)
Material	Fiberglass	معدل الرفع
Dimensions	120x65x100cm	قوة امتصاصها
Body Thickness	5mm	الجهد الكهربائي
Water Tanks	2	نوع المضخة
Tank capacity	2x50L	دورة في الدقيقة
Pump Type	Manual/Battery	سعة خزان المنظفات
Hose type & Length	7m Spring hose	أقصى درجة حرارة مدخل / مخرج





Vacuum Cleaner



SERIES F

Specifications	Wet & Dry			المواصفات
	F16B1	F17B1	F20F1	
Power	1000w	1000w	1000w	قوة الموتور
Power Supply	220v 50 hz	220v 50 hz	220v 50 hz	مزود الطاقة
Air flow	210 m ³ /h	210 m ³ /h	210 m ³ /h	تدفق الهواء
Vacuum	226 mBr	226 mB	226 mB	مكنسة
Noise Level	68dB	68dB	76dB	مستوى الضوضاء
Capacity	16 L	16 L	20 L	سعة
Tank	INOX	INOX	INOX	خزان
Weight	7 KG	7.5 KG	9 KG	وزن
Use	Dry	Wet & Dry	Wet & Dry	يستخدم
Accessories	32 Ømm	32 Ømm	40 Ømm	مُكَمَّلَات



F16B1/ F17B1



F20F1

Specifications	F30F1	Wet & Dry	المواصفات
Power	1000w		
Power Supply	220v 50 hz	مزود الطاقة	
Air flow	210 m ³ /h	تدفق الهواء	
Vacuum	226 mB	مكنسة	
Noise Level	74dB	مستوى الضوضاء	
Capacity	30 L	سعة	
Tank	INOX	خزان	
Weight	8.5 KG	وزن	
Use	Wet & Dry	يستخدم	
Accessories	40 Ømm	مُكَمَّلَات	



F30F1



F32F1



F32F1

Specifications	Wet & Dry			المواصفات
	F38F1	F39F1	F40F1	
Power	1000w	2x1000w	3x1000w	قوة الموتور
Power Supply	220v 50 hz	220v 50 hz	220v 50 hz	مزود الطاقة
Air flow	210 m ³ /h	425 m ³ /h	625 m ³ /h	تدفق الهواء
Vacuum	226 mBr	226 mB	226 mB	مكنسة
Noise Level	79dB	81dB	83dB	مستوى الضوضاء
Capacity	60 L	60 L	60 L	سعة
Tank	INOX	INOX	INOX	خزان
Weight	16 KG	18 KG	20 KG	وزن
Use	Wet & Dry	Wet & Dry	Wet & Dry	يستخدم
Accessories	40 Ømm	40 Ømm	40 Ømm	مُكَمَّلَات



F38F1/ F39F1/ F40F1

Wet & Dry



F44F1 / F48F1 / F56F1

Specifications	F44F1	F48F1	F56F1	المواصفات
Power	1000w	2x1000w	3x1000w	قوة الموتور
Power Supply	220v 50 hz	220v 50 hz	220v 50 hz	مزود الطاقة
Air flow	210 m ³ /h	425 m ³ /h	645 m ³ /h	تدفق الهواء
Vacuum	226 mB	226 mB	226 mB	مكنسة
Noise Level	79dB	81dB	83dB	مستوى الضوضاء
Capacity	60 L	60 L	60 L	سعة
Tank	INOX	INOX	INOX	خزان
Weight	20.5 KG	22.5 KG	24.5 KG	وزن
Use	Wet & Dry	Wet & Dry	Wet & Dry	يستخدم
Accessories	40 Ømm	40 Ømm	40 Ømm	مُكَمَّلَات

Wet & Dry



F52F1 /

Specifications	F52F1	F99F1	F50F1	F97F1	المواصفات
Power	2x1000w	3x1000w	2x1000w	3x1000w	قوة الموتور
Power Supply	220v 50 hz	220v 50 hz	220v 50 hz	220v 50 hz	مزود الطاقة
Air flow	425 m ³ /h	625 m ³ /h	425 m ³ /h	645 m ³ /h	تدفق الهواء
Vacuum	226 mB	226 mB	226 mB	226 mBr	مكنسة
Noise Level	81dB	83dB	81dB	83dB	مستوى الضوضاء
Capacity	75 L	75 L	75 L	75 L	سعة
Tank	INOX	INOX	INOX	INOX	خزان
Weight	23.5 KG	25 KG	20.5 KG	23 KG	وزن
Use	Wet & Dry	Wet & Dry	Wet & Dry	Wet & Dry	يستخدم
Accessories	50/90 Ømm	50/90 Ømm	50/90 Ømm	50/90 Ømm	مُكَمَّلَات

Wet & Dry



F50F1 / F97F1

Wet & Dry



F42F1 / F46F1 / F54F1

Specifications	F42F1	F46F1	F54F1	المواصفات
Power	1000w	2x1000w	3x1000w	قوة الموتور
Power Supply	220v 50 hz	220v 50 hz	220v 50 hz	مزود الطاقة
Air flow	210 m ³ /h	425 m ³ /h	645 m ³ /h	تدفق الهواء
Vacuum	226 mB	226 mB	226 mBr	مكنسة
Noise Level	79dB	81dB	83dB	مستوى الضوضاء
Capacity	60 L	60 L	60 L	سعة
Tank	INOX	INOX	INOX	خزان
Weight	18 KG	20 KG	22 KG	وزن
Use	Wet & Dry	Wet & Dry	Wet & Dry	يستخدم
Accessories	40 Ømm	40 Ømm	40 Ømm	مُكَمَّلَات

ACCESSORIES FOR SERIES F



A	Flexible Hose
B	Rigid Tube Bend
C	Flat Nozzle
D	Brush
E	Dry Vacuum Head
F	Carpet Brush
G	Wet Vacuum Head
H	Connector
OPTIONAL	
I	Radiator Brush
K	Plastic Extension
L	Oval Brush
M	Sofa Nozzle



Dry Cleaning **Wet Cleaning**



CLEAN AIR Series

Wet & Dry



C29F1

Specifications	C29F1	C61F1	C62F1	C63F1	المواصفات
Power	1000w	1000w	2x1000w	3x1000w	قوة الموتور
Power Supply	220v 50 hz	220v 50 hz	220v 50 hz	220v 50 hz	مزود الطاقة
Air flow	210 m ³ /h	210 m ³ /h	425 m ³ /h	645 m ³ /h	تدفق الهواء
Vacuum	226 mBr	226 mB	226 mB	226 mB	مكنسة
Noise Level	71.5dB	79dB	81dB	83dB	مستوى الضوضاء
Capacity	30 L	55 L	55 L	55 L	سعة
Tank	ABS	ABS	ABS	ABS	خزان
Weight	8.5 KG	17.5 KG	20 KG	22.5 KG	وزن
Use	Wet & Dry	Wet & Dry	Wet & Dry	Wet & Dry	يستخدم
Accessories	40 Ømm	40 Ømm	40 Ømm	40 Ømm	مُكَمَّلَات

Wet & Dry



C61F1/ C62F1/ C63F1

Wet & Dry



C64F1/ C65F1/ C66F1

Specifications	C64F1	C65F1	C66F1	المواصفات
Power	1000w	2x1000w	3x1000w	قوة الموتور
Power Supply	220v 50 hz	220v 50 hz	220v 50 hz	مزود الطاقة
Air flow	210 m ³ /h	425 m ³ /h	645 m ³ /h	تدفق الهواء
Vacuum	226 mB	226 mB	226 mBr	مكنسة
Noise Level	79dB	81dB	83dB	مستوى الضوضاء
Capacity	55 L	55 L	75 L	سعة
Tank	ABS	ABS	ABS	خزان
Weight	19.5 KG	22 KG	24.5 KG	وزن
Use	Wet & Dry	Wet & Dry	Wet & Dry	يستخدم
Accessories	40 Ømm	40 Ømm	40 Ømm	مُكَمَّلَات

Specifications

C71F1

C72F1

C73F1

المواصفات

Power	1000w	2x1000w	3x1000w	قوة الموتور
Power Supply	220v 50 hz	220v 50 hz	220v 50 hz	مزود الطاقة
Air flow	210 m ³ /h	425 m ³ /h	645 m ³ /h	تدفق الهواء
Vacuum	226 mB	226 mB	226 mB	مكنسة
Noise Level	79dB	81dB	83dB	مستوى الضوضاء
Capacity	75 L	75 L	75 L	سعة
Tank	ABS	ABS	ABS	خزان
Weight	18 KG	20.5 KG	23 KG	وزن
Use	Wet & Dry	Wet & Dry	Wet & Dry	يستخدم
Accessories	40 Ømm	40 Ømm	40 Ømm	مُكَمَّلَات

Wet & Dry



C71F1 / C72F1 / C73F1



Wet & Dry

Specifications	C74F1	C75F1	C76F1	المواصفات
Power	1000w	2x1000w	3x1000w	قوة الموتور
Power Supply	220v 50 hz	220v 50 hz	220v 50 hz	مزود الطاقة
Air flow	210 m ³ /h	425 m ³ /h	645 m ³ /h	تدفق الهواء
Vacuum	226 mB	226 mB	226 mBr	مكنسة
Noise Level	79dB	81dB	83dB	مستوى الضوضاء
Capacity	75 L	75 L	75 L	سعة
Tank	ABS	ABS	ABS	خزان
Weight	21 KG	23 KG	25 KG	وزن
Use	Wet & Dry	Wet & Dry	Wet & Dry	يستخدم
Accessories	40 Ømm	40 Ømm	40 Ømm	مُكَمَّلَات

C74F1 / C75F1 / C76F1



Wet & Dry

Specifications	C82F1	C83F1	C85F1	C85F1TS	المواصفات
Power	2x1000w	3x1000w	2x1000w	3x1000w	قوة الموتور
Power Supply	220v 50 hz	220v 50 hz	220v 50 hz	220v 50 hz	مزود الطاقة
Air flow	425 m ³ /h	645 m ³ /h	425 m ³ /h	645 m ³ /h	تدفق الهواء
Vacuum	226 mB	226 mB	226 mB	226 mB	مكنسة
Noise Level	81dB	83dB	81dB	83dB	مستوى الضوضاء
Capacity	75 L	75 L	75 L	75 L	سعة
Tank	ABS	ABS	ABS	ABS	خزان
Weight	21 KG	23.5 KG	24 KG	26 KG	وزن
Use	Wet & Dry	Wet & Dry	Wet & Dry	Wet & Dry	يستخدم
Accessories	50/90 Ømm	50/90 Ømm	50/90 Ømm	50/90 Ømm	مُكَمَّلَات

C82F1 / C83F1



Wet & Dry

C85F1 / C85F1(753TS)



A	Flexible Hose
B	Rigid Tube Bend
C	Flat Nozzle
D	Brush
E	Dry Vacuum Head
F	Carpet Brush
G	Wet Vacuum Head
H	Connector
OPTIONAL	
I	Radiator Brush
K	Plastic Extension

SERIE K INOX

Specifications	K17E1I-D
Power	1400w
Power Supply	230v 50 hz
Air flow	220 m ³ /h
Vacuum	255 mB
Noise Level	74dB
Capacity	20 L
Tank	INOX
Weight	9.8 KG
Use	Wet & Dry
Accessories	32 Ømm



Specifications	K30E1I-D
Power	1400w
Power Supply	230v 50 hz
Air flow	220 m ³ /h
Vacuum	255 mB
Noise Level	74dB
Capacity	35 L
Tank	INOX
Weight	10.6 KG
Use	Wet & Dry
Accessories	40 Ømm

المواصفات	K30E1I-D
قوة الموتور	1400w
مزود الطاقة	230v 50 hz
تدفق الهواء	220 m ³ /h
مكنسة	255 mB
مستوى الضوضاء	74dB
سعة	35 L
خزان	INOX
وزن	10.6 KG
يستخدم	Wet & Dry
مُكَمِّلات	40 Ømm



Specifications	K32E1I-D	K42F1-D	K46F1-D	K54F1-D	المواصفات
Power	1400w	1000w	2x1000w	3x1000w	قوة الموتور
Power Supply	230v 50 hz	230v 50 hz	230v 50 hz	230v 50 hz	مزود الطاقة
Air flow	220 m ³ /h	210 m ³ /h	425 m ³ /h	645 m ³ /h	تدفق الهواء
Vacuum	255 mBr	226 mB	226 mB	226 mB	مكنسة
Noise Level	74dB	76dB	76.5dB	78dB	مستوى الضوضاء
Capacity	35 L	50 L	50 L	50 L	سعة
Tank	INOX	INOX	INOX	INOX	خزان
Weight	16 KG	20 KG	22 KG	24.4 KG	وزن
Use	Wet & Dry	Wet & Dry	Wet & Dry	Wet & Dry	يستخدم
Accessories	40 Ømm	40 Ømm	40 Ømm	40 Ømm	مُكَمِّلات



Specifications	K44F1-D	K48F1-D	K56F1-D	المواصفات
Power	1000w	2x1000w	3x1000w	قوة الموتور
Power Supply	230v 50 hz	230v 50 hz	230v 50 hz	مزود الطاقة
Air flow	210 m ³ /h	425 m ³ /h	645 m ³ /h	تدفق الهواء
Vacuum	255 mB	226 mB	226 mBr	مكنسة
Noise Level	76dB	76.5dB	78dB	مستوى الضوضاء
Capacity	50 L	50 L	50 L	سعة
Tank	INOX	INOX	INOX	خزان
Weight	23 KG	25 KG	27.4 KG	وزن
Use	Wet & Dry	Wet & Dry	Wet & Dry	يستخدم
Accessories	40 Ømm	40 Ømm	40 Ømm	مُكَمِّلات

SERIE K INOX

Wet & Dry



K50F1-D/ K97F1-D

Specifications	K50F1-D	K97F1-D	K46-F1R	المواصفات
Power	2x1000w	3x1000w	2x1000w	قوة الموتور
Power Supply	230v 50 hz	230v 50 hz	230v 50 hz	مزود الطاقة
Air flow	425 m ³ /h	645 m ³ /h	425 m ³ /h	تدفق الهواء
Vacuum	226 mB	226 mB	226 mB	مكنسة
Noise Level	76.5dB	76.5dB	79dB	مستوى الضوضاء
Capacity	55 L	55 L	50 L	سعة
Tank	INOX	INOX	INOX	خزان
Weight	23 KG	25.9 KG	35 KG	وزن
Use	Wet & Dry	Wet & Dry	Wet & Dry	يستخدم
Accessories	50/90 Ømm	50/90 Ømm	40 Ømm	مُكمّلات

Wet & Dry



K46-F1R

Wet & Dry



K52F1-D/ K99F1-D

Specifications	K52F1-D	K99F1-D	K46-F2R	المواصفات
Power	2x1000w	3x1000w	2x1000w	قوة الموتور
Power Supply	230v 50 hz	230v 50 hz	230v 50 hz	مزود الطاقة
Air flow	425 m ³ /h	645 m ³ /h	645 m ³ /h	تدفق الهواء
Vacuum	226 mB	226 mB	226 mB	مكنسة
Noise Level	76.5dB	76dB	78dB	مستوى الضوضاء
Capacity	55 L	55 L	60 L	سعة
Tank	INOX	INOX	INOX	خزان
Weight	25.9 KG	28.3 KG	36 KG	وزن
Use	Wet & Dry	Wet & Dry	Wet & Dry	يستخدم
Accessories	50/90 Ømm	50/90 Ømm	40 Ømm	مُكمّلات

Wet & Dry



K46-F2R



A	Flexible Hose
B	Steel Hose Courbe Inox
C	Crevice
D	Round Brush
E	Floor Dry Tool
F	Carpet Brush
G	Squeegee Tool
H	Connector
I	Plastic Extension
K	Oval Brush
L	Upholster Tool
M	Heater Brush
N	Turbo Brush

SERIE K PLASTIC

Specifications	K17E1P-D	Wet & Dry	Wet & Dry	K28E1P-D	المواصفات
Power	1400w			1400w	قوة الموتور
Power Supply	230v 50 hz			230v 50 hz	مزود الطاقة
Air flow	220 m ³ /h			220 m ³ /h	تدفق الهواء
Vacuum	255 mB			255 mB	مكنسة
Noise Level	74dB			74dB	مستوى الضوضاء
Capacity	20 L			27 L	سعة
Tank	PEHD			PEHD	خزان
Weight	9.5 KG			8.5 KG	وزن
Use	Wet & Dry			Wet & Dry	يستخدم
Accessories	32 Ømm	K17E1P-D	K28E1P-D	32 Ømm	مُكَمَّلَات

Specifications	K29E1P-D	K61F1-D	K62F1-D	K63F1-D	المواصفات
Power	1400w	1000w	2x1000w	3x1000w	قوة الموتور
Power Supply	230v 50 hz	230v 50 hz	230v 50 hz	230v 50 hz	مزود الطاقة
Air flow	220 m ³ /h	210 m ³ /h	425 m ³ /h	645 m ³ /h	تدفق الهواء
Vacuum	255 mBr	226 mB	226 mB	226 mB	مكنسة
Noise Level	74dB	76dB	76.5dB	78dB	مستوى الضوضاء
Capacity	35 L	50 L	50 L	50 L	سعة
Tank	PEHD	PEHD	PEHD	PEHD	خزان
Weight	9.3 KG	19.5 KG	21.5 KG	24 KG	وزن
Use	Wet & Dry	Wet & Dry	Wet & Dry	Wet & Dry	يستخدم
Accessories	40 Ømm	40 Ømm	40 Ømm	40 Ømm	مُكَمَّلَات



K29E1P-D



K61F1/ K62F1/ K63F1-D

Specifications	K64F1-D	K65F1-D	K66F1-D	المواصفات
Power	1000w	2x1000w	3x1000w	قوة الموتور
Power Supply	230v 50 hz	230v 50 hz	230v 50 hz	مزود الطاقة
Air flow	210 m ³ /h	425 m ³ /h	645 m ³ /h	تدفق الهواء
Vacuum	226 mB	226 mB	226 mBr	مكنسة
Noise Level	76dB	76.5dB	78dB	مستوى الضوضاء
Capacity	50 L	50 L	50 L	سعة
Tank	PEHD	PEHD	PEHD	خزان
Weight	21.8 KG	23.8 KG	26.2 KG	وزن
Use	Wet & Dry	Wet & Dry	Wet & Dry	يستخدم
Accessories	40 Ømm	40 Ømm	40 Ømm	مُكَمَّلَات



K64F1/ K65F1/ K66F1-D

22
 Wet & Dry

K71FD/ K72FD/ K73FD-1

Specifications	K71FD-1	K72FD-1	K73FD-1	المواصفات
Power	1000w	2x1000w	3x1000w	قوة الموتور
Power Supply	230v 50 hz	230v 50 hz	230v 50 hz	مزود الطاقة
Air flow	210 m ³ /h	425 m ³ /h	645 m ³ /h	تدفق الهواء
Vacuum	226 mBr	226 mBr	226 mBr	مكنسة
Noise Level	76dB	76.5dB	78dB	مستوى الضوضاء
Capacity	55 L	55 L	55 L	سعة
Tank	PEHD	PEHD	PEHD	خزان
Weight	19.9 KG	21.9 KG	24.4 KG	وزن
Use	Wet & Dry	Wet & Dry	Wet & Dry	يستخدم
Accessories	40 Ømm	40 Ømm	40 Ømm	مُكَمَّلَات

 22
 Wet & Dry

K74FD/ K75FD/ K76FD-1

Specifications	K74FD-1	K75FD-1	K76FD-1	المواصفات
Power	1000w	2x1000w	3x1000w	قوة الموتور
Power Supply	230v 50 hz	230v 50 hz	230v 50 hz	مزود الطاقة
Air flow	210 m ³ /h	425 m ³ /h	645 m ³ /h	تدفق الهواء
Vacuum	226 mBr	226 mBr	226 mBr	مكنسة
Noise Level	76dB	76.5dB	78dB	مستوى الضوضاء
Capacity	55 L	55 L	55 L	سعة
Tank	PEHD	PEHD	PEHD	خزان
Weight	21.5 KG	23.5 KG	25.9 KG	وزن
Use	Wet & Dry	Wet & Dry	Wet & Dry	يستخدم
Accessories	40 Ømm	40 Ømm	40 Ømm	مُكَمَّلَات

 22
 Wet & Dry

K82FD-1/ K83FD-1

Specifications	K82FD-1	K83FD-1	K85FD-1	K86FD-1	المواصفات
Power	2x1000w	3x1000w	2x1000w	3x1000w	قوة الموتور
Power Supply	230v 50 hz	230v 50 hz	230v 50 hz	230v 50 hz	مزود الطاقة
Air flow	425 m ³ /h	645 m ³ /h	425 m ³ /h	645 m ³ /h	تدفق الهواء
Vacuum	226 mBr	226 mBr	226 mB	226 mB	مكنسة
Noise Level	76.5dB	78dB	76.5dB	78dB	مستوى الضوضاء
Capacity	55 L	55 L	55 L	55 L	سعة
Tank	PEHD	PEHD	PEHD	PEHD	خزان
Weight	22.3 KG	24.8 KG	24.5 KG	26.9 KG	وزن
Use	Wet & Dry	Wet & Dry	Wet & Dry	Wet & Dry	يستخدم
Accessories	50/90 Ømm	50/90 Ømm	50/90 Ømm	50/90 Ømm	مُكَمَّلَات

 22
 Wet & Dry

K85FD-1/ K86FD-1

Code: LSIM102



ماكينات التنظيف
(الغسيل والشطف وكنس الارضيات)

Industrial Vaccums,
Power Sweepers
& Scrubbers

TECHNICAL SPECIFICATIONS	LB4 L-ion	LB4 Electric
Vacuum motor (W)	400	700
Water lift mm/H ₂ O (in/H ₂ O)	1280 (50)	2300 (90)
Air volume lt./sec. (CFM)	30 (63)	52 (110)
Motor protection	Electronic	Thermo/Amp.
Battery charge level indicator and automatic shut OFF	Standard	-
Battery (Lithium - Ion)	36V - 6Ah	-
Run time (min.)	30	Non stop
Recharging time (min.)	90	-
Filter bag (3 layers microfiber) capacity (lt.)	4.5	4.5
Exhaust microfilter 3M Filtrete	Standard	Standard
Hepa Filter S-class	Optional	Optional
Noise level db(A)	64	69
Machine weight kg (lb)	4.9 (10.8) (with batt.)	3.8 (8.4)
Width suction/brush mm (in)	280 (11)	280 (11)
Double plug cable mt. (ft)	-	10 (32.8)
Insulation class	III	II
Energy consumption (class)	-	A+
Dimensions LxWxH mm (in)	235 x 200 x 495 (9.3 x 7.9 x 19.5)	

Code: LSIM101

ماكيتة شفط اسبريك

المواصفات	Specifications
سعة تانك	Waste Tank 240 ltr
السرعة	Max Speed F/R 4.5 km/h / 2.7km/h
قوة ماتور الشفط	Vacuum / Traction Motor 24v-1200w/1000w
البطاريات	Batteries 4x6v-12Ah-240Ah
مستوى الضوضاء	Noise Level 90dB
قوة التشغيل	Operating Range 3.5h
الأبعاد	Dimension 2000x940x1780mm
وزن الجهاز	Weight of Machine 300Kg

Vacuum Cleaner

Backpack B2004

ماكينة شفط الأتربة
معلقة على الظهر

Code: IFIM144



Specifications	B 2004	المواصفات
Power	1000w	قوة الموتور
Air Flow	184 m ³ /h	قوة سحب الهواء
Noise Level	69 dB	مستوى الضوضاء
Electric Cable length	15m	طول السلك
Weight	6.5Kg	الوزن
Dimensions (LxWxH)	251x220x650mm	الطول × العرض × الارتفاع

Vacuum Cleaner WHISPER

ماكينة الشفط الجاف
ذات منظم لصوت الموتور

Code: IFIM114

Specifications		المواصفات
Motor power	800 Watt	قوة الموتور
Water lift	245mBar	قوة السحب المياه
Air Flow	173 m ³ /h	قوة سحب الهواء
Tank capacity	11 lt	سعة التانك
Noise Level	50dB	مستوى الضوضاء
Paper bag capacity	10 L	سعة الكيس
Electric protection class	Double Insulation	مستوى الحماية
Cable length	7.5m	طول السلك
Weight	5.5kg	الوزن
Total height	350 mm	الارتفاع



Air Blower Hot & Cold

منفاخ هواء ساخن وبارد

Code: SC-2900



HOT
40~60° C



COLD
Room Tem.



Specifications				المواصفات
Motor	2900W			المتور
Fan speed	High: 160m³ / Medium: 120m³ / Low: 110m³			سرعة المروحة
Airflow	High	Medium	Low	معدل الهواء
Power Cable	12m			طول السلك
Electrical Supply	220V AC - 60Hz			الفولت
Dimension	Length: 54cm x Width: 44cm x Height: 55cm			القياسات
Weight	21kg.			الوزن



The three-gear speed regulation can satisfy the demands of various conditions.



Carpet Blower

ماكينة تجفيف السجاد

Code: IFIM108



Specifications		المواصفات
Construction	Rotationally moulded polyethylene with moulded offset handle & cord hooks	التعليمات
Motor	1/2HP continuous duty, capacitor start and thermally protected	الموتور
Fan speed	High: 1530 n/1'rpm Medium: 1250 n/1'rpm Low: 1025 n/1'rpm	سرعة المروحة
Airflow	High Medium Low	معدل الهواء
Power Cable	4.5mtr three-wire moulded plug	طول السلك
Electrical Supply	120V AC - 60Hz - 5 Amp	الفولت
Dimension	Length: 50cm Width: 43cm Height: 50cm	القياسات
Weight	14kg.	الوزن

Carpet Extraction Cleaner

ماكينة غسيل وتنشيف السجاد

Code: IFIM153

MAL 450

Code: IFIM152

L 215



Specifications	MAL 450	L215	المواصفات
Motor	2x1000W	1x1000W	الموتور
Water Lift	226mBar	226mBar	قوة السحب المياه
Solution Tank Capacity	23Ltr	10Ltr	سعة التانك
Recovery Tank	60Ltr	18Ltr	سعة تانك السحب
Noise Level	81dB	60dB	مستوى الضوضاء

Floorwash Machine

ماكينة غسيل الارضيات

Lightness and practicality for quick and effective cleaning



BATTERY OPERATED



ELECTRICAL OPERATED



Rapid



Lightweight and ultra compact



Brushless engine with artificial intelligence



Energy saving and consumption control



Large cleaning surface with 45 cm brushes



Reduced times of use



Li-ion battery to never stop

The battery with rechargeable lithium-ion technology guarantees 1 hour of autonomy of continuous operation. A high performance product with reduced consumption and energy savings.

Specifications	FB45	المواصفات
Motor power supply	580 Watt	مصدر طاقة المحرك
Motor power supply	36 V DC	مصدر طاقة المحرك
Total tank capacity	4 lt	إجمالي سعة الخزان
Recovery tank capacity	3 lt	سعة خزان الاسترداد
Work capacity	750 mq/h	القدرة على العمل
Cleaning surface length	450mm	طول سطح التنظيف
Front brush	Ø88,5 700 Rpm	فرشاة أمامية
Rear brush	Ø54 1140 Rpm	فرشاة خلفية
Total weight (empty)	12kg	الوزن الإجمالي (فارغ)
Dimension	140x485x330 mm	البعاد





F35 Floor Cleaner

Enhanced cleaning power in your work environment

The new F35 is an ultra-compact upright floor cleaner.

The unique design of the body and brushes of this professional floor cleaner means that it can even clean in areas that are difficult to access. With a cleaning surface area of 35 cm, it is ideal for home use as well as in hotels, restaurants, bars, schools, offices, shops and medical centres.



Transport wheels

Floorwash is equipped with two rear rubber wheels: simply tilt Floorwash towards you for safe and easy movement. Use the practical slot in the external tank for transport between different floors.



Technical Specifications F35

Body height 140mm	Body width 385mm
Body length 330mm	Front brush Ø86 700 rpm
Rear brush Ø54 1145 rpm	Cleaning surface length 385mm
Work capacity 200 mq/h	Motor capacity 400 W 2800 rpm
Total tank capacity 4 litres	Recovery tank capacity 1.8l
Total weight (empty) 11kg	





FB35 Floor Cleaner

Bigger and better.

Cleaning the floor without entangling power cords. This means using the FB35 floorwash. Its dimensions allow you to clean much larger surfaces thanks to the 60 minutes of autonomy.



High technology for improved cleaning

FB35 is not just a cordless floor cleaner, but a trove of technological innovations that make cleaning surfaces even faster and more efficient thanks to the innovative quick battery change system.



Technical Specifications FB35

Body height 140mm	Body width 385mm
Body length 330mm	Front brush Ø88.5 700 rpm
Rear brush Ø54 1145 rpm	Cleaning surface length 350mm
Work capacity 300 mq/h	Motor capacity 580 Watt
Motor power supply 36 V DC	Total tank capacity 4 litres
Recovery tank capacity 1,8 litres	



Specifications		المواصفات
Waste Tank	120 ltr	سعة تانك
Power	720W	قوة
Fuel Type	Petrol	نوع الوقود
Water Lift	30mBar	قوة السحب
Noise Level	102dB	مستوى الضوضاء
Operating Range	40Min	قوة التشغيل
Dimension	550x700x1350 mm	الأبعاد
Weight	40kg	الوزن

Specifications		المواصفات
Type	A70	يكتب
Work Mode	Hand Push	نظام العمل
Cleaning Width	92CM	عرض التنظيف
Main brush width	70CM	عرض الفرشاة الرئيسية
Capacity	40L	الاهلية
Net Weight	21KGS	الوزن الصافي
Gross Weight	23KGS	الوزن الإجمالي
Dimension	1250*950*1050MM	البعد
Packing Size	905*800*395MM	حجم التعبئة
Color	Gray & Orange	اللون
Machine Type	Floor Sweeper	نوع الجهاز
Certification	CE	شهادة
Use	Cleaning the floor	يستخدم
Cleaning Type	manual	نوع التنظيف
Material	Plastic	مادة

Hyper Grinder Machine -

HYPERLEVI 450

Code: HPL101

ماكينة جلي الأرضيات بقدرة فائقة

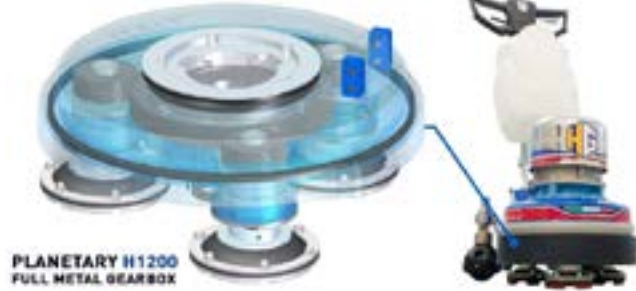

Specifications

Specifications		المواصفات
Model	HYPERLEVI 450 VS TOP	نموذج
Motor HP max	4 HP	محرك
Voltage	220	الجهد الكهربى
Hz	50/60	هرتز
Motor speed rpm	from 120 to 250	سرعة المحرك
Planetary speed	from 600 to 1300	سرعة الكواكب
Working width	450mm	عرض العمل
Tools Dimension	3x140mm	أبعاد الأدوات
Tank Liquids	20 lt	سوائل الخزان
Dimensions LxAxP cm	65x135x49	أبعاد
Weight Kg	123	وزن



Efficient: The new motors and inverters reduce power absorption increasing efficiency.

Fast: in the levelling and finishing steps.

Versatile: The complete range of accessories makes Hyperlevi suitable for any situation.

Easy to use: stable, silent and easy to handle.

Floor Polishing Machine

ماكينة ذات سرعة عالية لتلميع الأرضيات



Floor Maintainer High Speed

ماكينة ذات سرعة عالية لتلميع الأرضيات

Specifications	HS 1100	HS 1500	المواصفات
Voltage	220 / 240V 50 Hz 115 V 60 Hz	220 / 240V 50 Hz 115 V 60 Hz	الفولت
Disc speed	1100 rpm	1500 rpm	سرعة دوران الفرشاة
Disc diameter	508 mm (20")	508 mm (20")	قطر الفرشاة
Motor	1.5 HP 1125 Watt	1.5 HP 1125 Watt	الموتور
Net weight	37 Kg	37 Kg	الوزن

Floor Maintainer Jolly

ماكينة دك وتلميع الأرضيات
Suitable for all types of surfaces.



Sizes



Hard brush



Carpet soft brush



Driving pad



Superior planetary gear unit



Black pad - To clean deeply hard floors

White pad - To clean marble or granite

Red pad - For spray cleaning & metallized wax

Green pad - For resilient floors

Floor Maintainer c

ماكينة دك وتلميع الأرضيات

Specifications	Jolly 13	Jolly 17	Jolly 20	المواصفات
Cleaning width up to	330mm	430mm	500mm	عرض التنظيف
Cleaning Capacity up to	250m ² /h	300m ² /h	400m ² /h	كمية التنظيف
Brush speed rotation	150rpm	150rpm	150rpm	سرعة دوران الفرشاة
Noise Level	65dB	65dB	65dB	مستوى الضوضاء
Power	230v	230v	230v	الفولت
Brush motor	1100w	1100w	1100w	الوات
Elec.Cable Length	15m	15m	15m	طول السلك
Brush Diameter	13 in	17 in	20 in	قطر الفشاة
Weight	35 kg	40 kg	42 kg	الوزن

Scrubber Dryer Machine

ICM 16B /16E /18B / 18E

ماكينة غسل وتنشيف الأرضيات

Specifications	16B NEW	18B NEW	16E NEW	18E NEW	المواصفات
Scrubbing width	410mm	450mm	410mm	450mm	عرض الدعك
Cleaning capacity up to	1640m ² /h	1800m ² /h	1640m ² /h	1800m ² /h	كمية التنظيف
Operating range	3.0h	3.0h	-	-	مستوى التشغيل
Solution tank capacity	30L	30L	30L	30L	سعة تانك المواد
Recovery tank capacity	30L	30L	30L	30L	سعة تانك السحب
Forward speed	0-4km/h	0-4km/h	0-4km/h	0.4km/h	السرعة
Noise level	72dB	72dB	72dB	72dB	مستوى الضوضاء
Vacuum motor	24v - 550w	24v 550w	230v - 550w	230v 550w	قوة ماتور الشفط
Brush motor	1x24v 400w	1x24v 400w	1x230v 370w	1x230v 370w	قوة ماتور الفرشاة
Voltage	24v (2x12v-110Amp/h)	24v (2x12v-110Amp/h)	230v	230v	الفولت
Dimensions (L x W x H)	900x430x940mm	950x460x940mm	900x430x940mm	950x460x940mm	الطول - العرض - الارتفاع
Squeegee width	670mm	710mm	670mm	710mm	عرض المساحة
Weight of the Machine	60kg	60kg	60kg	60kg	الوزن

Scrubber Dryer Machine - Giampy

ماكينة غسيل وتنشيف الأرضيات

Specifications	20B	24B	المواصفات
Scrubbing width	500mm	600mm	عرض الدعك
Cleaning capacity up to	2000m ²	2400m ²	كمية التنظيف
Operating range	3-4 hours	3-4 hours	مستوى التشغيل
Solution tank capacity	50ltr	50ltr	سعة تانك المواد
Recovery tank capacity	50ltr	50ltr	سعة تانك السحب
Max Slope	3%	3%	طريقة العمل
Forward speed	0-4 km/h	0-4 km/h	السرعة
Water lift	107 mBar	107 mBar	قوة السحب
Brush pressure	20-40 kg	20-40 kg	قوة ضغط الفرشاة
Noise level	72dB	72dB	مستوى الضوضاء
Traction Motor	24v 100w	24v 130w	الفولت
Vacuum motor	24v 500w	24v 500w	قوة ماتور الشفط
Brush motor	1x24v 400w	1x24v 650w	قوة موتور الفرشاة
Voltage (Ah in C20)	2x24v 157 A/h	2x24v 157 A/h	الفولت
Diamensions	1000x550x1060mm	1000x710x1040mm	الأبعاد
Squeegee width	750mm	850mm	عرض المساحة
Weight of the machine (without batteries/water/operator)	91kg	105kg	الوزن
Weight of the Batteries Approx.	2x26kg	2x35kg	وزن البطاريات

Scrubber Dryer Machine

ماكينة غسل وتنشيف الأرضيات بسائق

Specifications	Ecosmile 65	Ecosmile 75	Ecosmile 85	المواصفات
Scrubbing width	680mm	734mm	835mm	عرض الدمك
Cleaning capacity upto	4000m ² /h	4500m ² /h	5000m ² /h	كمية التنظيف
Operating standard	5h	5h	5h	مدة التشغيل
Operating Hard floors	4.5h	4.5h	4.5h	مدة التشغيل الارضيات الخشنة
Solution tank capacity	150L	150L	150L	سعة تانك المواد
Recovery tank capacity	170L	170L	170L	سعة تانك السحب
Mechanical drive	Drive wheel	Drive wheel	Drive wheel	طريقة العمل
Forward speed	3-6 Km/h	3-6 Km/h	3-6 Km/h	السرعة
Max. slope	10 %	10 %	10 %	أقصى منحدر
Water lift	170mbar	170mbar	170mbar	قوة السحب المياه
Brush pressure	41 kg	46 kg	51 kg	ضغط الفرشاة
Noise Level	58dB	58dB	58dB	مستوى الضوضاء
Necessary width for U-turn	1720 mm	1720 mm	1720 mm	عرض اللازمة لمنعطف
Vacuum motor	300/500/750 w	300/500/750 w	300/500/750 w	قوة ماتور الشفط
Brush motor	2x450 W	2x450 W	2x450 W	قوة ماتور الفرشاة
Traction motor	500W	500W	500W	نوع ماتور الرفع
Voltage	48Vdc	48Vdc	48Vdc	الفولت
Batteries	4x12Vdc - 118Ah [C5]	4x12Vdc - 118Ah [C5]	4x12Vdc - 118Ah [C5]	البطاريات
Messures: L x W x H	1350 x 650 x 1360mm	1350 x 650 x 1360mm	1350 x 650 x 1360mm	القياسات
No. of Brushes & Diameter	2 x Ø 350mm	2 x Ø 405mm	2 x Ø 430mm	عدد الفرش والقطر
Squeegee width	870 mm	960 mm	1045 mm	عرض السحب

Scrubber Dryer Machine

ماكينة غسيل وتنشيف الأرضيات بسائق

Specifications	ICM 34 UE	ICM 38 UE	المواصفات
Scrubbing width	850mm	1000mm	عرض الدعك
Cleaning capacity up to	5100m ² /h	6000m ² /h	كمية التنظيف
Operating range	5.0h	5.0h	مدة التشغيل
Solution tank capacity	190L	190L	سعة تانك المواد
Recovery tank capacity	180L	180L	سعة تانك السحب
Forward speed	0-6km/h	0-6km/h	السرعة
Water lift	157mBar	157mBar	قوة السحب
Brush pressure	0-60kg	0-60kg	قوة ضغط الفرشاة
Noise level	83dB	83dB	مستوى الضوضاء
Vacuum / Traction motor	2x850w / 2x550w	2x850w / 2x550w	قوة ماتور الضغط
Brush motor	2x750w	3x750w	قوة ماتور الفرشاة
Voltage	36v/290A	36v/290A	الفولت
Dimensions (L x W x H)	1800x1050x1460mm	1800x1050x1460mm	الطول - العرض - الارتفاع
Brush	2xØ410mm	3xØ330mm	الفرشاة
Squeegee width	1300mm	1300mm	عرض المساحة
Weight of the Batteries Approx.	385kg	405kg	وزن البطاريات

Specifications	ICM 42 TD	ICM 60 TD	المواصفات
Scrubbing width	1250mm	1500mm	عرض الدمك
Cleaning capacity up to	15000m ² /h	18000m ² /h	كمية التنظيف
Solution tank capacity	260L	260L	سعة تانك المواد
Recovery tank capacity	260L	260L	سعة تانك سحب المياه
Waste Tank Capacity	15L	15L	سعة تانك سحب الأتربة
Forward speed	0-12 km/h	0-12 km/h	السرعة
Water lift	166mBar	166mBar	قوة السحب
Brush pressure	0-120kg	0-120kg	قوة ضغط الفرشاة
Noise level	85dB	85dB	مستوى الضوضاء
Vacuum / Traction motor	2x850w / 2x OP 160c	2x850w / 2x OP 160c	قوة ماتور الشفط
Brush motor	3x or 80 C.	3x or 80 C.	قوة موتور الفرشاة
Starting Battery	12v - 350A - 40A/h	12v - 350A - 40A/h	البطاريات
Feeding (Diesel)	Diesel	Diesel	التشغيل (ديزل / بنزين / غاز)
Mark (Model of the engine)	Kubota	Kubota	موديل المحرك
N. cylinders	3	3	عدد السلندرات
Power/Rounds (Kw/rpm)	18.8 HP / 3600	18.8 HP / 3600	عدد الدورات / ساعة
Cooling	Water	Water	المبرد
Dimensions (L x W x H)	2100x1300x1400mm	2100x1550x1400mm	الطول - العرض - الارتفاع
Squeegee width	1470mm	1650mm	عرض المساحة

Specifications	Mini Sweeper	المواصفات
Sweeping width	700mm	عرض الكنس
Cleaning capacity up to	4200m ² /h	كمية التنظيف
Operating range	2.5h	مدة التشغيل
Waste tank capacity	33L	سعة تانك السحب
Mechanical drive	Rear	طريقة العمل
Noise level	65dB	مستوى الضوضاء
Vacuum Motor	With Fan	موتور السحب
Central Brush Motor	1x650w 24v	قوة الفرشة الوسطية
Side Brush Motor	1x60w 24v	قوة الفرشة الجانبية
Voltage	2x12v 157A/h 24V	الفولت
Dimension (L x W x H)	1110 x 765 x 1200 mm	الطول × العرض × الارتفاع
Weight of the machine (without batteries / water / operator)	110 kg	الوزن
Weight of the batteries (approx)	2 x 26 kg	وزن البطاريات

Specifications	S 28 B	S 28 D	المواصفات
Sweeping width 1Brush / 2 Brush	900mm /1100mm	900mm /1100mm	عمل عرض الكنس فرشاة ٢ / فرشاة
Cleaning capacity up to	5000m ² /h	6600m ² /h	كمية التنظيف
Operating Range	4h	-	مدة التشغيل
Waste Tank Capacity	70L	70L	سعة تانك السحب
Filtering Surface	6m ²	6m ²	الفلتر
Forward speed	0-5 km/h	0-6 km/h	السرعة
Noise level	68dB	75dB	مستوى الضوضاء
Vacuum / Traction motor	24v-180w / 700w	- / 125 OMR Hydro	قوة ماتور الشفط
Voltage	24v 4x6v/330A	-	الفولت
Dimensions (L x W x H)	1390x875x1178mm	1390x875x1178mm	الطول × العرض × الأرتفاع
Weight of the machine	270kg	336kg	الوزن
Dumping Type	Electric-hydraulic	Electric-hydraulic	طريقة التفريغ
Dumping Height	1310mm	1310mm	ارتفاع التفريغ

Specifications	S 32	المواصفات
Sweeping width 1Brush / 2 Brush	1000mm /1350mm	عمل عرض الكنس فرشاة ٢ / فرشاة
Cleaning capacity up to	6600m ² /h	كمية التنظيف
Operating Range	4h	مدة التشغيل
Waste Tank Capacity	200L	سعة تانك السحب
Filtering Surface	6m ²	الفلتر
Forward speed	0-5 km/h	السرعة
Noise level	80dB	مستوى الضوضاء
Vacuum / Traction motor	250w / Hydraulic	قوة ماتور الشفط
Voltage	-	الفولت
Dimensions (L x W x H)	1820x1080x1365mm	الطول × العرض × الارتفاع
Weight of the machine	620kg	الوزن
Dumping Type	Electric-hydraulic	طريقة التفريغ
Dumping Height	1300mm	ارتفاع التفريغ

Industrial Power Sweeper

ماكينة كنس الشوارع ومواقف السيارات بسائق

Specifications	S34 B	S34 D	المواصفات
Sweeping width 1brush / 2brush	1150mm / 1450mm	1150mm / 1450mm	عرض كنس
Cleaning capacity up to	10150m ² /h	11750m ² /h	كمية التنظيف
Operating Range	3h	-	مدة التشغيل
Waste Tank Capacity	230L	230L	سعة تانك السحب
Filtering Surface	5.5/7m ²	5.5/7m ²	الفلتر
Forward speed	7 km/h	8.1 km/h	السرعة
Noise level	80.5dB	81.5dB	مستوى الضوضاء
Vacuum motor	250w	250w	قوة ماتور الشفط
Voltage (Ah in C20)	36v/330amp	-	الفولت
Dimensions (L x W x H)	2150x1185x1470mm	2150x1185x1470mm	الطول × العرض × الارتفاع
Weight of the machine	755kg	760kg	الوزن
Dumping Height	1340mm	1340mm	ارتفاع التفريغ

Industrial Power Sweeper

ماكينة كنس الشوارع ومواقف السيارات بسائق

Specifications	S 38 NEW B	S 38 NEW D	المواصفات
Scrubbing width (2brushes)	1540mm	1540mm	عرض الدعك
Cleaning Capacity upto	10472 m2/h	11920 m2/h	كمية التنظيف
Waste Tank Capacity	350L	350L	سعة تانك السحب
Dumping height	1490mm	1490mm	ارتفاع التفريغ
Filter type (Panel-bag)	bag	bag	الفلتر
Forward Speed	6.8km/h	7.74km/h	السرعة
Max Slope	9%	15%	الحد الأقصى المنحدر
Noise Level	78dB	81.5dB	مستوى الضوضاء
Vacuum Motor	550w	hydraulic	قوة موتور الشفط
Central Brush Motor	hydraulic	hydraulic	قوة الفرشة الوسطية
Side Brush Motor	hydraulic	hydraulic	قوة الفرشة الجانبية
Supply Voltage	36v	/	الفولت
Cooling	/	Water	التبريد
Dimension LxWxH	2130x1300x1490	2130x1300x1490	الابعاد
Central Brush	Ø 320 x 950mm	Ø 320 x 950mm	الفرشة الوسطية
Side Brush	Ø 550mm	Ø 550mm	الفرشة الجانبية
Weight of the machine	916kg	1050 Kg	الوزن

Industrial Power Sweeper

ماكينة كس الشوارع ومواقف السيارات بسائق

Specifications	S 48 NEW B	S 48 NEW D	المواصفات
Sweeping width (1/2brushes)	1450/1800mm	1450/1800mm	عرض الكس
Cleaning Capacity upto	16200 m2/h	21600 m2/h	كمية التنظيف
Waste Tank Capacity	/	/	سعة تالك السحب
Dumping height	1450mm	1450mm	ارتفاع التفريغ
Filter type (Panel-bag)	bag	bag	الفلتر
Filtering Surface	16.8m2	16.8m2	تصفية السطح
Forward Speed	9km/h	12km/h	السرعة
Max Slope	10%	13%	الحد الأقصى المنحدر
Noise Level	80dB	82dB	مستوى الضوضاء
Vacuum Motor	800w	hydraulic	قوة موتور الشفط
Central Brush Motor	hydraulic	hydraulic	قوة الفرشة الوسطية
Side Brush Motor	hydraulic	hydraulic	قوة الفرشة الجانبية
Supply Voltage	48v	/	الفولت
Fuel Type	/	Diesel	نوع الوقود
Diamension LxWxH	2270x1515x1510mm	2270x1515x1510mm	الابعاد
Central Brush	Ø 380 x 1250mm	Ø 300 x 1250mm	الفرشة الوسطية
Side Brush	Ø 560mm	Ø 560mm	الفرشة الجانبية
Weight of the machine	1500kg	1504 Kg	الوزن

Scrubber Dryer & Sweeper

ماكينة غسيل وتنشيف وكنس الأرضيات بسائق

Specifications	i115 SS	المواصفات
Scrubbing width	1150mm	عرض الدعك
Cleaning capacity up to	6900m ² /h	كمية التنظيف
Operating Range	3H	مدة التشغيل
Solution tank capacity	220L	سعة تانك المواد
Recovery tank capacity	210L	سعة تانك سحب المياه
Waste Tank Capacity	210L	سعة تانك سحب الأتربة
Forward speed	0-6 km/h	السرعة
Water lift	175mBar	قوة السحب
Brush pressure	0-180kg	قوة ضغط الفرشاة
Noise level	75dB	مستوى الضوضاء
Vacuum / Traction motor	2x36v 500w / hydraulic	قوة ماتور الشفط
Scrubbing motor	3x 36v 350w 3500rpm	قوة موتور الدعك
Starting Battery	36v - 630A/h	البطاريات
Dimensions (L x W x H)	2100x1200x1420mm	الأبعاد
No. Brushes	3x Ø 380mm	عدد الفرشاة
Front side Brushes	2x Ø 550mm	فرش الجانب الأمامي
Squeegee width	1350mm	عرض المساحة
Weight of the machine	960 Kg	وزن الجهاز

Specifications	S 150	المواصفات
Scrubbing width (2brushes)	1250mm	عرض الدعك
Sweeping width (3brushes)	2000	عمل عرض الكنس فرشاة / 3 فرشاة
Cleaning Capacity upto (2 / 3 brushes)	15000 m2/h / 24000 m2/h	كمية التنظيف
Waste Tank Capacity	1m ³	سعة تانك السحب
Dumping height	1520mm	ارتفاع التفريغ
Working Speed	12km/h	سرعة العمل
Transfer Speed	30km/h	سرعة نقل
Max Slope	25%	الحد الأقصى المنحدر
Fuel Tank Capacity	46L	سعة خزان الوقود
Water Tank Capacity	270L	سعة خزان الماء
Vacuum Motor	Hydraulic	قوة موتور الشفط
Central Brush Motor	hydraulic	قوة الفرشة الوسطية
Side Brush Motor	hydraulic	قوة الفرشة الجانبية
Supply Voltage	12v	الفولت
Fuel Type	Diesel	نوع الوقود
Diamension LxWxH	3400x1250x1980mm	الابعاد
Side Brush 2/3 brushes	Ø 700 / Ø 800mm	الفرشة الجانبية
Weight of the machine	2400kg	الوزن

Specifications	AF 6000	المواصفات
Scrubbing width (2brushes)	1400mm	عرض الدمك
Sweeping width (3brushes)	2070	عمل عرض الكنس فرشاة 3 / فرشاة
Cleaning Capacity upto (2 / 3 brushes)	-	كمية التنظيف
Waste Tank Capacity	6m ³	سعة تانك السحب
Dumping height	1280 (+ optional 2350)	ارتفاع التفريغ
Working Speed	42km/h	سرعة العمل
Transfer Speed	-	سرعة نقل
Max Slope	-	الحد الأقصى المنحدر
Fuel Tank Capacity	-	سعة خزان الوقود
Water Tank Capacity	-	سعة خزان الماء
Vacuum Motor	Hydraulic	قوة موتور الشفط
Central Brush Motor	hydraulic	قوة الفرشة الوسطية
Side Brush Motor	hydraulic	قوة الفرشة الجانبية
Supply Voltage	12v	الفولت
Fuel Type	Diesel	نوع الوقود
Diamension LxWxH	-	الابعاد
Side Brush 2/3 brushes	-	الفرشة الجانبية
Weight of the machine	-	الوزن



SCARPAVAPOR – BF425S

Professional steam generator for cleaning shoes, bags, accessories and more..

Benefits

- Full cleaning
- Sanitization with ozone and regeneration
- Hot air drying at 38°C

Applications environments



Shoe cleaning



Bags



Belts, gloves, accessories



Helmets

Our Gallery



SCARPAVAPOR NO LIMITS – BF426S

Scarpavapor® No Limits is the perfect machine to clean: shoes, carpets, bags, car seats, helmets, sofas, etc.

Thanks to the power of steam and to the specific tools, you can guarantee the total removal of all spots.

Applications environments



Shoemakers and
shoemaking



Laundries

Our Gallery



01



Speedy Foam – Foam generator with brush

Otional accessory: cleaning foam
5kg RIP1484
Needs compressed air to operate

02



Operating desk for SCARPAVAPOR - 2010

With the SCARPAVAPOR working board you will have a comfortable workstation and increase productivity and satisfaction in your job
Data sheet

03



Vacuum clean 1000W – Dr. 240 W/Hose F/SCARPAVAPOR RIP2011

Otional accessory: cleaning foam
5kg RIP1484
Needs compressed air to operate



دوسات للمداخل
للمحماية من الغبار والأتربة بمراكز التسوق
والمكاتب والمباني العامة

Entrance mats

Keep the dust and other dirt away from shopping malls, office buildings and public facilities



Scrub Filling



Rubber Filling



Brush Filling

Multi-coloured rubber openwork mats with optional cleaning brushes, as well as technically more advanced mats in aluminium profiles with either rubber, scrub or rubber an scrub filling.





موقع معرض الشركة Showroom Location Map



Disclaimer

Images and technical specification of products and accessories are not binding and can be modified without notice



الشركة العربية للتنظيف ذ.م.م. ARAB CLEANING CO. W.L.L

A Complete Cleaning Products Supplier

Industrial Vacuum Cleaners, Floor Machines, Power Sweepers, Steam Generators, Pressure Washers, Chemicals, Detergents, Polishes, Hygiene & Industrial Paper Products, Dispensers & Holders, Trolleys, Containers & Litter Bins, Cleaning Tools and Accessories, Catering Consumable & Disposables and more...

توريد كافة مواد التنظيف

مواد جرين سيل (مدمقة للبيئة) واكوابيل وحلال، مواد كيميائية للتنظيف، منتجات ورقية، معطر جو، أجهزة أدوات التنظيف، مستهلكات التجهيزات، عربات، معدات التنظيف، السلوولت، معدات التنظيف

OUR BRANDS



Proud supplier of



GREEN SEAL CERTIFIED
PAPER, CHEMICAL PRODUCTS
& FLOORINGS



ECOLABEL CERTIFIED
PAPER & CHEMICAL
PRODUCTS



CRE APPROVED
MACHINES



ANTIBACTERIAL
APPROVED



ECOFRIENDLY
PRODUCTS



ALCOHOL FREE
SANITIZER



NO DIGRIDABLE
GARBAGE BAGS



ZERO
NATURAL
PRODUCTS



REUSE
REDUCE
RECYCLE



RESPONSIBLY
MANAGED FORESTS



ISSA
MEMBER

Visit us for a complete product list at
www.arabcleaning.com

E-mail: info@arabcleaning.com

P.O. Box 23654 Safat 13097 Kuwait.

Fax: +965 2481 7036 - 247 216 16

